

# Technical Information

What you need to know to BUILD WITH LIGHT<sup>®</sup>

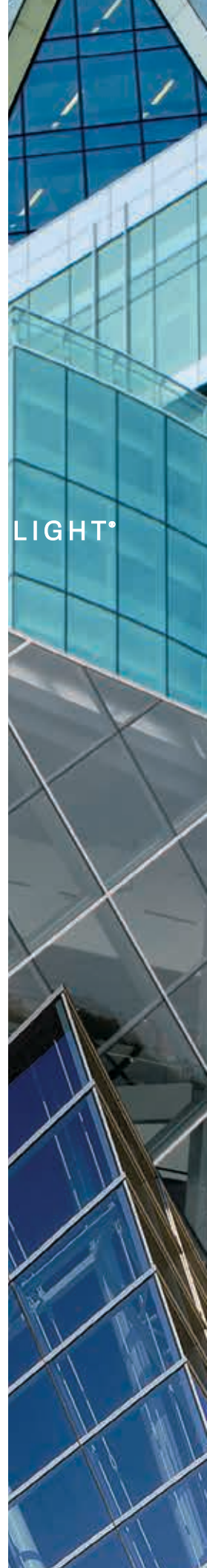

INTRODUCTION	1
TYPES OF GLASS	2
Annealed Glass	
Heat-strengthened Glass	
Tempered Glass	
Laminated Glass	
Insulating Glass	
Warm-Edge Spacer	
Tinted Glass vs. Low-E Coated Glass	
Spandrel Glass	
Common Glass Configurations	
Hurricane Glass	
Bird-Friendly Glass	
Turtle Glass	
PERFORMANCE CHARACTERISTICS OF GLASS	7
Energy Conservation and Coated Glass	
SunGuard Advanced Architectural Glass	
Glass Performance: Spectral Graphs	
Acoustical Information	
How to View/Evaluate Glass Hand Samples	
FABRICATION AND GLAZING	17
Optical Distortion	
Thermal Breakage	
Construction-Phase Risks of Thermal Breakage	
Statistical Probability of Glass Breakage	
Heat-Soaking	
Wind Load	
Bending SunGuard Coated Glass	
Strain Pattern	
Moiré Pattern	
Glass Edge Types	
Glass Handling, Storage, Maintenance and Cleaning	
Coated Glass: Minimum & Maximum Sizes	
Oversize Glass: Insulating and Heat-treatment Considerations	
Glazing Guidelines	
Quality/Inspection Guidelines	
OTHER RESOURCES	26
Architectural Tools	
Standards Used in Architectural Glass	
Warranty	
GLOSSARY OF TERMS	28



# Architectural Glass

## Introduction

---

Architects, designers and builders have more choices of glass today than ever before. Those choices can make a tremendous difference in your project's cost, energy efficiency and environmental impact. So you need accurate, detailed information to ensure that you choose the right glass.

This brochure provides technical information – including performance capabilities and glazing guidelines – for all types of SunGuard Advanced Architectural Glass from Guardian. It also contains instructions for the proper handling, maintenance and cleaning of the glass before, during and after building construction. We believe that you'll find most of the answers you need in this brochure, but you're always welcome to call us at 1-866-GuardSG (482-7374) to consult with a SunGuard Advanced Architectural Glass specialist or to order a glass sample.



*Photo: © Ben Benschneider*

## Types of Glass

Getting the right type of glass – or the right combination of types – can be critical to the success of your project. This section defines the various kinds of glass, how they’re made, and their strengths and characteristics. It also diagrams construction techniques to show how different glass types can be combined for the desired heat, light and insulation properties.

### ANNEALED GLASS

Float glass (also called “flat” glass) that has not been heat-strengthened or tempered is annealed glass. Annealing float glass is the process of controlled cooling to prevent residual stress in the glass and is an inherent operation of the float glass manufacturing process. Annealed glass can be cut, machined, drilled, edged and polished.

### HEAT-STRENGTHENED GLASS

Heat-strengthened (HS) glass has been subjected to a heating and cooling cycle and is generally twice as strong as annealed glass of the same thickness and configuration. HS glass must achieve residual surface compression between 3,500 and 7,500 PSI for 6mm glass, according to ASTM C 1048. Please contact Guardian regarding thicker glass standards. HS glass has greater resistance to thermal loads than annealed glass and, when broken, the fragments are typically larger than those of fully tempered glass and initially may remain in the glazing opening. Heat-strengthened glass is not a safety glass product as defined by the various code organizations. This type of glass is intended for general glazing, where additional strength is desired to withstand wind load and thermal stress. It does not require the strength of fully tempered glass, and is intended for applications that do not specifically require a safety glass product. When heat-treated glass is necessary, Guardian Glass recommends the use of heat-strengthened glass for applications that do not specifically require a safety glass product. HS glass cannot be cut or drilled after heat-strengthening and any alterations, such as edge-grinding, sandblasting or acid-etching, can cause premature failure.

### TEMPERED GLASS

Fully tempered glass is approximately four times stronger than annealed glass of the same thickness and configuration, and residual surface compression must be over 10,000 PSI for 6mm, according to ASTM C 1048. Please contact Guardian for thicker glass standards. When broken, it will break into many relatively small fragments, which are less likely to cause serious injury. The typical process to produce tempered glass involves heating the glass to over 1,000 degrees F, then rapidly cooling to lock the glass surfaces in a state of compression and the core in a state of tension as shown in the diagram.

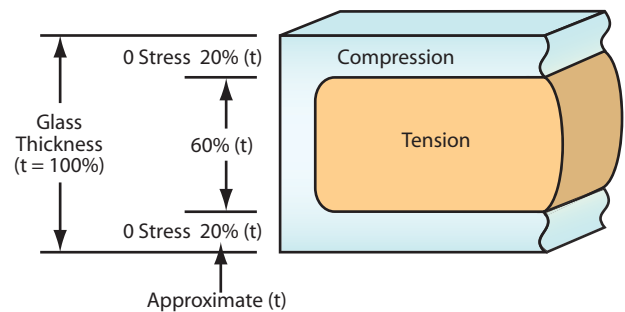



Tempered glass is often referred to as “safety glass” because it meets the requirements of the various code organizations that set standards for safety glass. This type of glass is intended for general glazing, and safety glazing such as sliding doors, storm doors, building entrances, bath and shower enclosures, interior partitions and other uses requiring superior strength and safety properties. Tempered glass cannot be cut or drilled after tempering, and any alterations, such as edge-grinding, sandblasting or acid-etching, can cause premature failure.

LAMINATED GLASS

Laminated glass is two or more lites (pieces) of glass permanently bonded together with one or more plastic interlayers (PVB) using heat and pressure. The glass and interlayers can be a variety of colors and thicknesses designed to meet building code standards and requirements as necessary. Laminated glass can be broken, but the fragments will tend to adhere to the plastic layer and remain largely intact, reducing the risk of injury. Laminated glass is considered “safety glass” because it meets the requirements of the various code organizations that set standards for safety. Heat-strengthened and tempered glass can be incorporated into laminated glass units to further strengthen the impact resistance. Hurricane resistance, the need for bomb blast protection, sound attenuation and ballistic or forced-entry security concerns are all primary uses for laminated glass. For complete industry-accepted information about laminated glass, please review the Glass Association of North America’s Laminated Glazing Reference Manual.

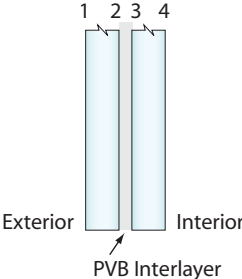

INSULATING GLASS

Insulating glass refers to two or more lites of glass sealed around the edges with an air space between, to form a single unit. Commonly referred to as an “IG unit,” insulating glass is the most effective way to reduce air-to-air heat transfer through the glazing. When used in conjunction with low-E and/or reflective glass coatings, IG units become effective means to conserve energy and comply with energy codes. The most common architectural insulating glass unit configuration is ¼" glass - ½" air space - ¼" glass (6 mm - 12 mm air space - 6 mm).

As low-E coatings have become better at reducing air-to-air heat transfer, spacer technology has become the focus of incremental thermal improvements. Typical commercial spacers are composed of formed aluminum filled with desiccant to absorb any residual moisture inside the IG unit, thus reducing potential condensation. While this is a structurally strong material, the aluminum-to-glass contact point is a very efficient thermal conductor and can increase the potential for temperature differential between the center of glass and the edge of glass, which can lead to condensation and reduces the unit’s overall U-Value.

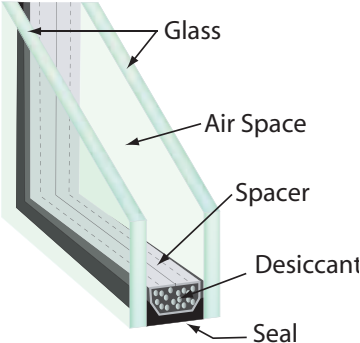

WARM-EDGE SPACER



Warm-edge spacer technology is another option for improving the thermal properties, reducing condensation and reducing U-values in IG units. There are a number of warm-edge spacer designs available, all of which thermally break the metal-to-glass contact point to some degree, while offering varying levels of structural integrity that may or may not be suitable for commercial applications. Warm-edge spacers can significantly reduce heat conduction when compared to conventional metal spacers.

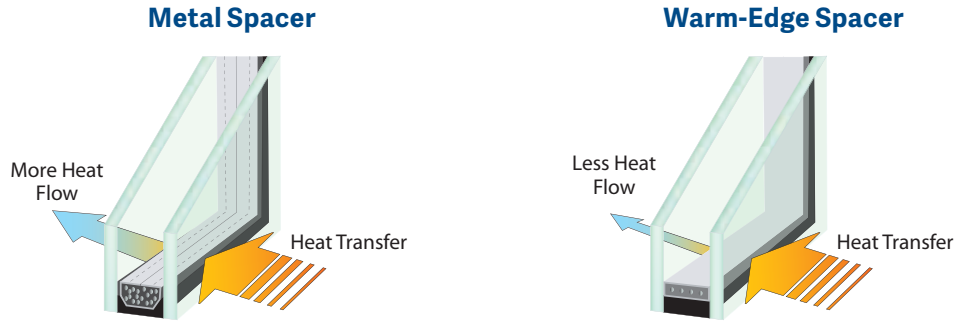

TINTED GLASS (HEAT-ABSORBING) VS. LOW-E COATED GLASS

Low-E coatings reduce the amount of direct solar energy entering the building. Before the development of low-E coatings, architects relied on tinted (heat-absorbing glass) or reflective coatings to reduce solar energy transmission. Tinted glass almost always requires heat-treatment to reduce potential thermal stress and breakage and tends to reradiate the absorbed heat. Reflective coatings are effective at reducing heat gain but also reduce visible light transmission. Low-E coatings reflect solar energy away from the glazing, often without requiring heat-treatment, and generally have lower visible light reflection.

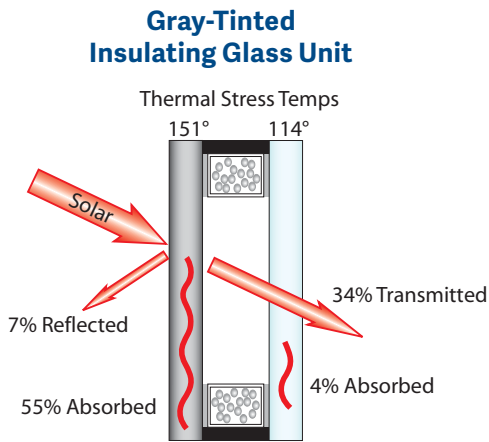

**Tinted Glass (heat-absorbing glass)**  
 6 mm gray float glass outboard / 6mm clear inboard  
 $T_{vis} = 39\%$   $SHGC = 0.46$

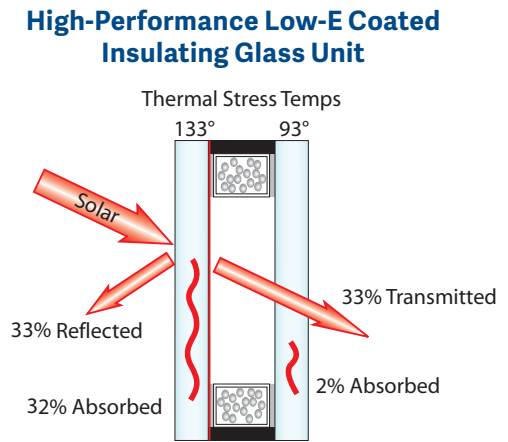

**Low-E Glass (heat-reflecting glass)**  
 6 mm clear w/SunGuard SuperNeutral 68 outboard / 6mm clear inboard  
 $T_{vis} = 68\%$   $SHGC = 0.38$

## SPANDREL GLASS

Spandrel glass is the area of glass panels that conceal structural building components such as columns, floors, HVAC systems, electrical wiring, plumbing, etc. Spandrel glass is typically located between vision glass on each floor of a building.

Curtainwall and structurally glazed designs often require the use of spandrel glass to achieve a designer’s vision of the finished project. Spandrel glass applications can be a complementary or contrasting color with respect to the vision glass appearance. Spandrel glass must be heat-treated to avoid thermal stress breakage. Guardian has extensive experience with spandrel glass applications and can help architects and building owners achieve the desired appearance, while reducing the risk of thermal stress breakage.

When high light-transmitting or low-reflecting vision glass is specified, achieving an exact spandrel match can be difficult. Daylight conditions can have a dramatic effect on the perception of vision to spandrel appearance. For instance, a clear, bright sunny day produces highly reflective viewing conditions and may provide a good vision to spandrel glass match. A gray, cloudy day may allow more visual transmission from the exterior and produce more contrast between the vision and spandrel glass. Guardian recommends full-size, outdoor mock-ups be prepared and approved in order to confirm the most desirable spandrel option for a specific project.

## COMMON GLASS CONFIGURATIONS

The following images depict the most common glass configurations and identify the glass surfaces with numbers showing the glass surfaces counting from exterior to interior.

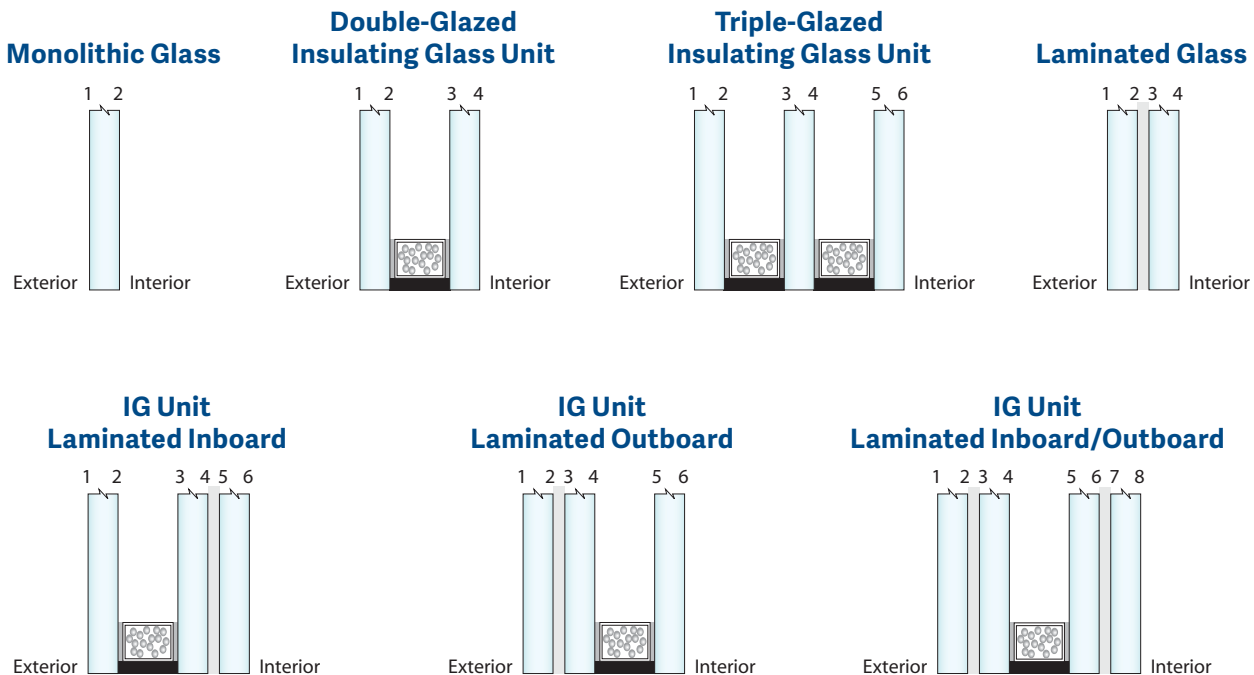



**HURRICANE GLASS**

Hurricane codes in coastal areas of North America help to prevent catastrophic building failure during hurricane conditions. Initially, Dade County, Florida, enacted requirements that have been used as a model for other areas such as Texas and the Gulf Coast, as well as up the Atlantic Seaboard. The codes may vary regionally, so design professionals are encouraged to research the local municipality codes when beginning new projects. The diagram indicates basic Dade County, Florida, code requirements for small and large missile glazing testing.

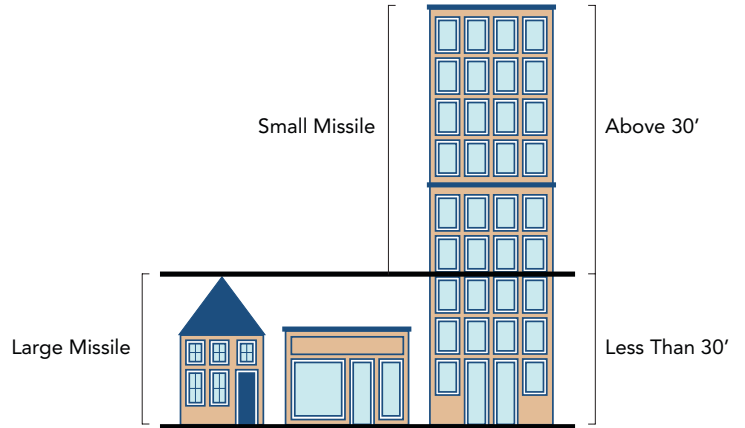

**BIRD-FRIENDLY GLASS**

The American Bird Conservancy (ABC) estimates millions of birds die in collisions with buildings each year. ABC has worked with LEED (Leadership in Energy and Environmental Design) to incorporate solutions for bird-friendly architecture into its green building certification guidelines. LEED now offers a pilot bird credit for those who design and build in a bird-friendly manner.

**TURTLE GLASS**

It has been discovered that light shining brightly from buildings within the line of sight of the seashore attracts marine turtle hatchlings away from their natural environment at sea. Due to this behavior, the design of projects along the Florida coastline requires adherence to the Florida Model Lighting Ordinance for Marine Turtle Protection. The ordinance requires architectural glass installed in coastal buildings to transmit no more than 45 percent of interior light.



## Performance Characteristics

---

*What are the effects of wind and heat on architectural glass? What degree of light reflectance and heat absorption can be expected? What optical and acoustical effects are normal? This section shows how to get the maximum performance from SunGuard Advanced Architectural Glass.*

### ENERGY CONSERVATION AND COATED GLASS

The use of coated glass and insulating glass units can have a significant impact on the energy consumption of commercial buildings. A reduction in HVAC system cooling capacity reduces the initial investment, and annual savings from reduced energy consumption for heating and cooling requirements provides a return on glazing investment year after year. Studies have shown that over a 10-year period, the energy savings from high-performance coated glass can be several hundred thousand dollars for a typical six-story building, and the payback can be as little as two years.

Guardian Glass has invested substantial resources over the years in search of improved solar heat gain and U-values of commercial coated glass products. The SunGuard product line is one of the results of that investment – a wide range of performance characteristics to meet varying local and regional energy codes as well as some of the highest performing, most energy-efficient coatings available today.

### SUNGUARD ADVANCED ARCHITECTURAL GLASS

The SunGuard glass product line is designed to deliver energy efficiency that will meet or exceed energy code requirements and includes products offering a variety of aesthetically pleasing color options. The SuperNeutral<sup>®</sup> Series presents the highest-performing energy characteristics available in high light-transmitting low-E coatings from Guardian. Our High Performance Series provides a range of light transmission, reflection and energy conservation qualities to choose from. And our Solar product lets the design professional work with a traditional “reflective” coating that is excellent at lowering heat gain.

All SunGuard Advanced Architectural Glass products are distributed through Guardian’s independent Select Fabricator network. Guardian has established this network to promote consistent quality and availability. Select Fabricators can provide glass samples for mock-ups and can typically offer faster delivery than many competitors.

The following tables provide glass performance figures for a wide variety of SunGuard products and glass makeups. Please contact Guardian at 1-866-GuardSG (482-7374) if you need additional information.



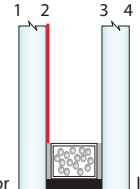

## Insulating Glass Data

Product	Outboard - Inboard Substrate	Appearance	Transmittance			Reflectance			U-Value Winter Nighttime		Relative Heat Gain	Solar Heat Gain Coefficient	Light to Solar Gain (LSG)
			Visible Light %	Ultra-violet %	Solar Energy %	Visible Light Out %	Visible Light In %	Solar Energy Out %	Air	Argon			
<b>SunGuard SuperNeutral</b>			Coating #2 Surface						6 mm/12.7 mm a.s./6 mm				
SNX 62/27	UltraClear - UltraClear	Ultra Clear	64	8	24	11	13	51	0.29	0.24	65	0.27	2.40
	Clear - Clear	Clear	62	6	23	11	12	39	0.29	0.24	65	0.27	2.31
	Green - Clear	Green	52	3	18	9	12	10	0.29	0.24	59	0.24	2.13
	CrystalGray - Clear	Light Gray	44	3	16	8	11	19	0.29	0.24	54	0.22	1.98
	Gray - Clear	Gray	31	3	12	6	11	19	0.29	0.24	45	0.18	1.71
	CrystalBlue - Clear	Blue	40	4	15	7	11	25	0.29	0.24	51	0.21	1.91
SNX 51/23	UltraClear - UltraClear	Light Blue	53	14	20	14	14	46	0.29	0.24	57	0.23	2.28
	Clear - Clear	Light Blue	51	11	19	14	14	36	0.29	0.24	57	0.23	2.19
	Green - Clear	Blue-Green	43	5	15	11	13	10	0.29	0.24	52	0.22	1.99
	CrystalGray - Clear	Light Gray	36	6	14	9	13	18	0.29	0.24	48	0.20	1.85
	Gray - Clear	Gray	26	5	10	7	13	17	0.29	0.24	41	0.16	1.57
	CrystalBlue - Clear	Blue	33	7	13	9	13	23	0.29	0.24	46	0.19	1.78
SN 68	UltraClear - UltraClear	Ultra Clear	71	40	37	11	13	43	0.29	0.25	94	0.39	1.80
	Clear - Clear	Clear	68	30	33	11	12	33	0.29	0.25	90	0.38	1.80
	Green - Clear	Green	57	13	23	9	12	9	0.29	0.25	72	0.30	1.92
	CrystalGray - Clear	Light Gray	48	17	23	8	11	16	0.29	0.25	71	0.30	1.64
	Gray - Clear	Gray	34	13	18	6	11	16	0.29	0.25	61	0.25	1.37
	CrystalBlue - Clear	Blue	44	19	23	7	11	21	0.29	0.25	70	0.29	1.51
SN 54	UltraClear - UltraClear	Ultra Clear	56	22	26	13	19	44	0.29	0.24	69	0.29	1.96
	Clear - Clear	Clear	54	16	24	13	18	35	0.29	0.24	68	0.28	1.92
	Green - Clear	Green	45	7	17	11	18	10	0.29	0.24	58	0.24	1.89
	CrystalGray - Clear	Light Gray	38	9	17	9	18	17	0.29	0.24	56	0.23	1.67
	Gray - Clear	Gray	27	7	13	7	17	16	0.29	0.24	48	0.19	1.40
	CrystalBlue - Clear	Blue	35	10	16	8	17	22	0.29	0.24	54	0.22	1.57
SNR 43	UltraClear - UltraClear	Light Silver	45	24	21	28	14	54	0.29	0.24	56	0.23	1.96
	Clear - Clear	Light Silver	43	17	19	28	14	43	0.29	0.24	56	0.23	1.89
	Green - Clear	Green	36	8	14	21	14	14	0.29	0.24	50	0.20	1.78
	CrystalGray - Clear	Silver Gray	31	9	13	16	14	21	0.29	0.24	47	0.19	1.59
	Gray - Clear	Silver Gray	22	8	10	10	13	19	0.29	0.24	41	0.17	1.31
	CrystalBlue - Clear	Silver Blue	28	11	13	14	13	26	0.29	0.24	46	0.19	1.50
<b>SunGuard High Performance</b>			Coating #2 Surface - except where noted (#3)										
Neutral 78/65(#3)	UltraClear - UltraClear	Ultra Clear	81	54	66	13	13	23	0.31	0.27	171	0.72	1.12
	Clear - Clear	Clear	78	39	55	13	13	19	0.31	0.27	156	0.66	1.18
Neutral 78/65	UltraClear - UltraClear	Ultra Clear	81	54	66	13	13	22	0.31	0.27	160	0.68	1.19
	Clear - Clear	Clear	78	39	55	13	13	18	0.31	0.27	147	0.62	1.26
Neutral 50	Clear - Clear	Neutral Blue	50	31	32	16	11	20	0.33	0.29	95	0.39	1.27
	Green - Clear	Green	42	13	20	13	10	9	0.33	0.29	68	0.28	1.50
Neutral 40	Clear - Clear	Neutral Gray	40	27	25	21	12	23	0.33	0.29	78	0.32	1.25
	Green - Clear	Green	34	11	16	16	12	10	0.33	0.29	59	0.24	1.40
AG 50	UltraClear - UltraClear	Light Silver	52	43	33	28	19	41	0.30	0.25	86	0.36	1.45
	Clear - Clear	Light Silver	50	30	29	27	19	34	0.30	0.25	82	0.34	1.48
	Green - Clear	Green	42	12	18	21	18	13	0.30	0.25	61	0.25	1.66
	CrystalGray - Clear	Silver Gray	35	16	20	16	18	18	0.30	0.25	64	0.26	1.34
	Gray - Clear	Silver Gray	25	12	16	10	18	16	0.30	0.25	57	0.23	1.08
	CrystalBlue - Clear	Silver Blue	32	17	20	14	18	21	0.30	0.25	65	0.27	1.20
AG 43	UltraClear - UltraClear	Light Silver	45	38	30	30	15	40	0.30	0.26	80	0.33	1.34
	Clear - Clear	Light Silver	43	26	26	30	15	33	0.30	0.26	76	0.31	1.37
	Green - Clear	Green	36	11	16	22	15	13	0.30	0.26	57	0.23	1.55
	CrystalGray - Clear	Silver Gray	30	14	18	17	14	18	0.30	0.26	60	0.25	1.23
	Gray - Clear	Silver Gray	21	11	15	11	14	15	0.30	0.26	54	0.22	0.98
	CrystalBlue - Clear	Silver Blue	28	15	18	15	14	20	0.30	0.26	61	0.25	1.10
<b>SunGuard Solar</b>													
Silver 20	Clear - Clear	Silver	18	16	14	30	30	26	0.37	0.33	56	0.22	0.81
	Green - Clear	Silver Green	15	7	8	23	30	12	0.37	0.33	46	0.18	0.83

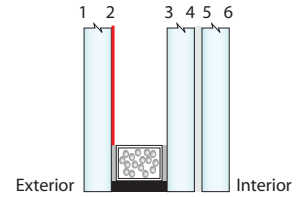

## Insulating Glass w/ Lami Inboard Data

Product	Outboard - Inboard Substrate	Appearance	Transmittance			Reflectance			U-Value Winter Nighttime		Relative Heat Gain	Solar Heat Gain Coefficient	Light to Solar Gain (LSG)
			Visible Light %	Ultra-violet %	Solar Energy %	Visible Light Out %	Visible Light In %	Solar Energy Out %	Air	Argon			
									6 mm/12.7 mm a.s./6 mm/.090 PVB/6 mm				
<b>SunGuard SuperNeutral</b>			Coating #2 Surface						6 mm/12.7 mm a.s./6 mm/.090 PVB/6 mm				
SNX 62/27	UltraClear - UC/UC	Ultra Clear	63	0	23	11	12	51	0.28	0.23	64	0.26	2.37
	Clear - Clr/Clr	Clear	59	0	21	11	12	39	0.28	0.23	64	0.26	2.25
	Green - Clr/Clr	Green	50	0	17	9	11	10	0.28	0.23	58	0.24	2.09
	CrystalGray - Clr/Clr	Light Gray	42	0	15	8	11	19	0.28	0.23	53	0.22	1.94
	Gray - Clr/Clr	Gray	30	0	11	6	10	19	0.28	0.23	44	0.18	1.67
	CrystalBlue - Clr/Clr	Blue	38	0	14	7	11	25	0.28	0.23	50	0.21	1.87
SNX 51/23	UltraClear - UC/UC	Light Blue	52	0	19	14	14	45	0.28	0.23	56	0.23	2.26
	Clear - Clr/Clr	Light Blue	49	0	17	14	13	36	0.28	0.23	56	0.23	2.14
	Green - Clr/Clr	Blue-Green	41	0	14	11	12	10	0.28	0.23	51	0.21	1.95
	CrystalGray - Clr/Clr	Light Gray	35	0	12	9	12	18	0.28	0.23	47	0.19	1.81
	Gray - Clr/Clr	Gray	25	0	9	7	12	17	0.28	0.23	40	0.16	1.54
	CrystalBlue - Clr/Clr	Blue	32	0	12	9	12	23	0.28	0.23	45	0.18	1.74
SN 68	UltraClear - UC/UC	Ultra Clear	69	0	34	11	12	42	0.28	0.24	92	0.39	1.79
	Clear - Clr/Clr	Clear	66	0	30	11	12	33	0.28	0.24	89	0.37	1.77
	Green - Clr/Clr	Green	55	0	21	9	11	9	0.28	0.24	70	0.29	1.88
	CrystalGray - Clr/Clr	Light Gray	47	0	21	8	11	16	0.28	0.24	70	0.29	1.61
	Gray - Clr/Clr	Gray	33	0	16	6	10	16	0.28	0.24	59	0.24	1.35
	CrystalBlue - Clr/Clr	Blue	42	0	21	7	11	21	0.28	0.23	69	0.29	1.49
SN 54	UltraClear - UC/UC	Ultra Clear	55	0	24	13	18	44	0.28	0.24	68	0.28	1.94
	Clear - Clr/Clr	Clear	52	0	21	13	17	34	0.28	0.24	67	0.28	1.88
	Green - Clr/Clr	Green	44	0	16	10	17	10	0.28	0.24	57	0.24	1.85
	CrystalGray - Clr/Clr	Light Gray	37	0	15	9	17	17	0.28	0.24	55	0.23	1.64
	Gray - Clr/Clr	Gray	26	0	12	7	16	16	0.28	0.24	47	0.19	1.37
	CrystalBlue - Clr/Clr	Blue	34	0	15	8	16	22	0.28	0.23	53	0.22	1.54
SNR 43	UltraClear - UC/UC	Light Silver	44	0	19	28	14	54	0.28	0.23	55	0.23	1.94
	Clear - Clr/Clr	Light Silver	41	0	17	28	13	43	0.28	0.23	55	0.22	1.86
	Green - Clr/Clr	Green	35	0	13	21	13	14	0.28	0.23	49	0.20	1.75
	CrystalGray - Clr/Clr	Silver Gray	29	0	12	16	13	21	0.28	0.23	46	0.19	1.56
	Gray - Clr/Clr	Silver Gray	21	0	9	10	13	19	0.28	0.23	40	0.16	1.29
	CrystalBlue - Clr/Clr	Silver Blue	27	0	12	14	13	26	0.28	0.23	45	0.18	1.47
<b>SunGuard High Performance</b>			Coating #2 Surface - except where noted (#3)										
Neutral 78/65(#3)	UltraClear - UC/UC	Ultra Clear	80	0	60	13	12	23	0.30	0.26	168	0.71	1.12
	Clear - Clr/Clr	Clear	76	0	47	12	12	19	0.30	0.26	153	0.64	1.17
Neutral 78/65	UltraClear - UC/UC	Ultra Clear	79	0	60	13	13	21	0.30	0.26	158	0.67	1.19
	Clear - Clr/Clr	Clear	75	0	47	13	12	18	0.30	0.26	143	0.60	1.25
Neutral 50	Clear - Clr/Clr	Neutral Blue	48	0	27	16	10	20	0.32	0.28	92	0.38	1.26
	Green - Clr/Clr	Green	40	0	17	13	10	9	0.32	0.28	66	0.27	1.49
Neutral 40	Clear - Clr/Clr	Neutral Gray	39	0	21	20	11	23	0.32	0.28	76	0.31	1.24
	Green - Clr/Clr	Green	32	0	14	16	11	10	0.32	0.28	57	0.23	1.39
AG 50	UltraClear - UC/UC	Light Silver	51	0	30	28	19	41	0.29	0.25	85	0.35	1.44
	Clear - Clr/Clr	Light Silver	48	0	25	27	18	34	0.29	0.25	80	0.33	1.46
	Green - Clr/Clr	Green	40	0	16	20	17	13	0.29	0.25	60	0.25	1.64
	CrystalGray - Clr/Clr	Silver Gray	34	0	17	16	17	18	0.29	0.25	63	0.26	1.32
	Gray - Clr/Clr	Silver Gray	24	0	14	10	17	16	0.29	0.25	55	0.23	1.06
	CrystalBlue - Clr/Clr	Silver Blue	31	0	17	14	17	21	0.29	0.25	63	0.26	1.19
AG 43	UltraClear - UC/UC	Light Silver	44	0	27	30	15	40	0.29	0.25	79	0.33	1.34
	Clear - Clr/Clr	Light Silver	41	0	22	29	14	33	0.29	0.25	74	0.30	1.36
	Green - Clr/Clr	Green	35	0	14	22	14	13	0.29	0.25	55	0.23	1.53
	CrystalGray - Clr/Clr	Silver Gray	29	0	15	17	14	18	0.29	0.25	59	0.24	1.22
	Gray - Clr/Clr	Silver Gray	21	0	12	11	13	15	0.29	0.25	52	0.21	0.97
	CrystalBlue - Clr/Clr	Silver Blue	27	0	16	15	14	20	0.29	0.25	60	0.24	1.09
<b>SunGuard Solar</b>													
Silver 20	Clear - Clr/Clr	Silver	17	0	11	30	28	26	0.36	0.32	53	0.21	0.82
	Green - Clr/Clr	Silver Green	15	0	7	23	28	12	0.36	0.32	44	0.18	0.83



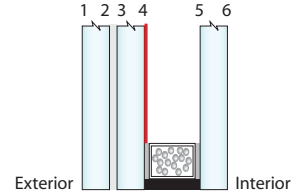

## Insulating Glass w/ Lami Outboard Data

Product	Outboard - Inboard Substrate	Appearance	Transmittance			Reflectance			U-Value Winter Nighttime		Relative Heat Gain	Solar Heat Gain Coefficient	Light to Solar Gain (LSG)
			Visible Light %	Ultra-violet %	Solar Energy %	Visible Light Out %	Visible Light In %	Solar Energy Out %	Air	Argon			
<b>SunGuard SuperNeutral</b>			Coating #4 Surface						6 mm/.090 PVB/6 mm/12.7 mm a.s./6 mm				
SNX 62/27	UC/UC - UltraClear	Ultra Clear	63	0	23	11	12	39	0.28	0.23	66	0.27	2.31
	Clear/Clr - Clear	Clear	59	0	21	11	12	24	0.28	0.23	66	0.27	2.18
	Green/Clr - Clear	Green	50	0	17	9	12	8	0.28	0.23	57	0.24	2.10
	CrystalGray/Clr - Clr	Light Gray	42	0	15	8	11	13	0.28	0.23	54	0.22	1.91
	Gray/Clr - Clear	Gray	30	0	11	6	11	12	0.28	0.23	45	0.18	1.63
	CrystalBlue/Clr - Clear	Blue	38	0	14	7	11	16	0.28	0.23	51	0.21	1.82
SNX 51/23	UC/UC - UltraClear	Light Blue	52	0	19	14	14	35	0.28	0.23	58	0.24	2.18
	Clear/Clr - Clear	Light Blue	49	0	17	13	13	22	0.28	0.23	58	0.24	2.05
	Green/Clr - Clear	Blue-Green	41	0	14	11	13	8	0.28	0.23	51	0.21	1.96
	CrystalGray/Clr - Clr	Light Gray	35	0	12	9	13	12	0.28	0.23	48	0.20	1.78
	Gray/Clr - Clear	Gray	25	0	9	7	13	11	0.28	0.23	41	0.17	1.49
	CrystalBlue/Clr - Clear	Blue	32	0	12	8	13	14	0.28	0.23	46	0.19	1.68
SN 68	UC/UC - UltraClear	Ultra Clear	69	0	34	11	13	32	0.28	0.24	91	0.38	1.81
	Clear/Clr - Clear	Clear	66	0	30	11	12	20	0.28	0.24	86	0.36	1.82
	Green/Clr - Clear	Green	55	0	21	9	12	7	0.28	0.24	68	0.28	1.95
	CrystalGray/Clr - Clr	Light Gray	47	0	21	8	11	11	0.28	0.24	68	0.28	1.66
	Gray/Clr - Clear	Gray	33	0	16	6	11	10	0.28	0.24	58	0.24	1.39
	CrystalBlue/Clr - Clear	Blue	42	0	21	7	11	13	0.28	0.23	67	0.28	1.53
SN 54	UC/UC - UltraClear	Ultra Clear	55	0	24	13	19	34	0.28	0.24	70	0.29	1.91
	Clear/Clr - Clear	Clear	52	0	21	13	18	21	0.28	0.24	68	0.28	1.85
	Green/Clr - Clear	Green	44	0	16	10	18	8	0.28	0.24	56	0.23	1.88
	CrystalGray/Clr - Clr	Light Gray	37	0	15	9	17	11	0.28	0.24	55	0.23	1.64
	Gray/Clr - Clear	Gray	26	0	12	7	17	11	0.28	0.24	47	0.19	1.36
	CrystalBlue/Clr - Clear	Blue	34	0	15	8	17	14	0.28	0.23	54	0.22	1.53
SNR 43	UC/UC - UltraClear	Light Silver	44	0	19	27	14	42	0.28	0.23	57	0.23	1.89
	Clear/Clr - Clear	Light Silver	41	0	17	26	14	28	0.28	0.23	56	0.23	1.81
	Green/Clr - Clear	Green	35	0	13	20	14	11	0.28	0.23	48	0.20	1.76
	CrystalGray/Clr - Clr	Silver Gray	29	0	12	15	14	14	0.28	0.23	47	0.19	1.54
	Gray/Clr - Clear	Silver Gray	21	0	9	10	13	13	0.28	0.23	41	0.16	1.26
	CrystalBlue/Clr - Clear	Silver Blue	27	0	12	14	13	17	0.28	0.23	46	0.19	1.44
<b>SunGuard High Performance</b>			Coating #4 Surface - except where noted (#5)										
Neutral 78/65(#5)	UC/UC - UltraClear	Ultra Clear	79	0	60	13	13	17	0.30	0.26	158	0.67	1.18
	Clear/Clr - Clear	Clear	75	0	47	12	13	12	0.30	0.26	136	0.58	1.31
Neutral 78/65	UC/UC - UltraClear	Ultra Clear	79	0	60	13	13	16	0.30	0.26	150	0.64	1.25
	Clear/Clr - Clear	Clear	75	0	47	12	13	11	0.30	0.26	129	0.55	1.38
Neutral 50	Clear/Clr - Clear	Neutral Blue	48	0	27	15	11	13	0.32	0.28	87	0.36	1.32
	Green/Clr - Clear	Green	40	0	17	12	10	8	0.32	0.28	64	0.26	1.54
Neutral 40	Clear/Clr - Clear	Neutral Gray	39	0	21	19	12	16	0.32	0.28	74	0.30	1.27
	Green/Clr - Clear	Green	32	0	14	15	12	9	0.32	0.28	56	0.23	1.42
AG 50	UC/UC - UltraClear	Light Silver	51	0	30	27	19	32	0.29	0.25	83	0.35	1.47
	Clear/Clr - Clear	Light Silver	48	0	25	26	19	22	0.29	0.25	76	0.32	1.52
	Green/Clr - Clear	Green	40	0	16	19	18	11	0.29	0.25	58	0.24	1.70
	CrystalGray/Clr - Clr	Silver Gray	34	0	17	15	18	12	0.29	0.25	60	0.25	1.37
	Gray/Clr - Clear	Silver Gray	24	0	14	10	18	11	0.29	0.25	53	0.22	1.10
	CrystalBlue/Clr - Clear	Silver Blue	31	0	17	13	18	14	0.29	0.25	61	0.25	1.24
AG 43	UC/UC - UltraClear	Light Silver	44	0	27	29	15	31	0.29	0.25	78	0.32	1.35
	Clear/Clr - Clear	Light Silver	41	0	22	28	15	22	0.29	0.25	71	0.29	1.40
	Green/Clr - Clear	Green	35	0	14	21	14	11	0.29	0.25	54	0.22	1.57
	CrystalGray/Clr - Clr	Silver Gray	29	0	15	16	14	13	0.29	0.25	57	0.23	1.26
	Gray/Clr - Clear	Silver Gray	21	0	12	10	14	11	0.29	0.25	51	0.21	1.00
	CrystalBlue/Clr - Clear	Silver Blue	27	0	16	14	14	14	0.29	0.25	58	0.24	1.13
<b>SunGuard Solar</b>													
Silver 20	Clear/Clr - Clear	Silver	17	0	11	28	30	20	0.36	0.32	55	0.22	0.79
	Green/Clr - Clear	Silver Green	15	0	7	21	30	11	0.36	0.32	45	0.18	0.81



## Laminated Outboard & Inboard Data

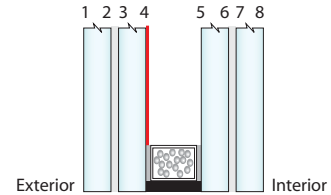

Product	Outboard - Inboard Substrate	Appearance	Transmittance			Reflectance			U-Value Winter Nighttime		Relative Heat Gain	Solar Heat Gain Coefficient	Light to Solar Gain (LSG)
			Visible Light %	Ultra-violet %	Solar Energy %	Visible Light Out %	Visible Light In %	Solar Energy Out %	Air	Argon			
									6 mm/.090 PVB/6 mm/12.7 mm a.s./6 mm/.090 PVB/6 mm				
<b>SunGuard SuperNeutral</b>			Coating #4 Surface						6 mm/.090 PVB/6 mm/12.7 mm a.s./6 mm/.090 PVB/6 mm				
SNX 62/27	UC/UC - UC/UC	Ultra Clear	61	0	23	11	12	39	0.27	0.23	65	0.27	2.27
	Clear/Clr - Clear/Clr	Clear	57	0	20	11	12	24	0.27	0.23	65	0.27	2.12
	Green/Clr - Clear/Clr	Green	48	0	16	9	11	8	0.27	0.23	57	0.23	2.05
	CrystalGray/Clr - Clr/Clr	Light Gray	41	0	14	8	11	12	0.27	0.23	53	0.22	1.87
	Gray/Clr - Clear/Clr	Gray	29	0	11	6	10	12	0.27	0.23	44	0.18	1.60
	CrystalBlue/Clr - Clr/Cl	Blue	37	0	14	7	11	16	0.27	0.23	51	0.21	1.78
SNX 51/23	UC/UC - UC/UC	Light Blue	51	0	18	14	13	35	0.27	0.23	57	0.24	2.15
	Clear/Clr - Clear/Clr	Light Blue	47	0	16	13	13	22	0.27	0.23	57	0.24	2.00
	Green/Clr - Clear/Clr	Blue-Green	40	0	13	11	12	8	0.27	0.23	50	0.21	1.92
	CrystalGray/Clr - Clr/Clr	Light Gray	34	0	12	9	12	12	0.27	0.23	47	0.19	1.74
	Gray/Clr - Clear/Clr	Gray	24	0	9	7	12	11	0.27	0.23	40	0.16	1.46
	CrystalBlue/Clr - Clr/Cl	Blue	31	0	11	8	12	14	0.27	0.23	46	0.19	1.65
SN 68	UC/UC - UC/UC	Ultra Clear	68	0	33	11	12	32	0.27	0.23	90	0.38	1.79
	Clear/Clr - Clear/Clr	Clear	63	0	27	10	12	20	0.27	0.23	85	0.35	1.78
	Green/Clr - Clear/Clr	Green	53	0	20	9	11	7	0.27	0.23	67	0.28	1.91
	CrystalGray/Clr - Clr/Clr	Light Gray	45	0	19	8	11	11	0.27	0.23	66	0.28	1.62
	Gray/Clr - Clear/Clr	Gray	32	0	15	6	10	10	0.27	0.23	57	0.23	1.36
	CrystalBlue/Clr - Clr/Cl	Blue	41	0	19	7	10	13	0.27	0.23	66	0.27	1.50
SN 54	UC/UC - UC/UC	Ultra Clear	54	0	23	13	18	34	0.27	0.23	69	0.29	1.88
	Clear/Clr - Clear/Clr	Clear	50	0	20	12	17	21	0.27	0.23	67	0.28	1.81
	Green/Clr - Clear/Clr	Green	42	0	15	10	17	8	0.27	0.23	55	0.23	1.84
	CrystalGray/Clr - Clr/Clr	Light Gray	36	0	14	9	17	11	0.27	0.23	54	0.22	1.60
	Gray/Clr - Clear/Clr	Gray	25	0	11	7	16	11	0.27	0.23	46	0.19	1.33
	CrystalBlue/Clr - Clr/Cl	Blue	32	0	14	8	16	14	0.27	0.23	53	0.22	1.49
SNR 43	UC/UC - UC/UC	Light Silver	43	0	18	27	14	42	0.27	0.23	56	0.23	1.87
	Clear/Clr - Clear/Clr	Light Silver	40	0	16	26	13	28	0.27	0.23	55	0.23	1.76
	Green/Clr - Clear/Clr	Green	34	0	12	20	13	11	0.27	0.23	47	0.19	1.73
	CrystalGray/Clr - Clr/Clr	Silver Gray	28	0	11	15	13	14	0.27	0.23	46	0.19	1.51
	Gray/Clr - Clear/Clr	Silver Gray	20	0	8	10	13	13	0.27	0.23	40	0.16	1.24
	CrystalBlue/Clr - Clr/Cl	Silver Blue	26	0	11	14	13	17	0.27	0.23	45	0.18	1.41
<b>SunGuard High Performance</b>			Coating #4 Surface - except where noted (#5)										
Neutral 78/65(#5)	UC/UC - UC/UC	Ultra Clear	78	0	57	12	12	16	0.29	0.25	157	0.67	1.17
	Clear/Clr - Clear/Clr	Clear	73	0	42	12	11	12	0.29	0.25	134	0.57	1.29
Neutral 78/65	UC/UC - UC/UC	Ultra Clear	78	0	57	13	13	15	0.29	0.25	148	0.63	1.23
	Clear/Clr - Clear/Clr	Clear	72	0	42	12	12	11	0.29	0.25	127	0.54	1.35
Neutral 50	Clear/Clr - Clear/Clr	Neutral Blue	46	0	24	15	10	13	0.31	0.27	85	0.35	1.30
	Green/Clr - Clear/Clr	Green	39	0	16	12	10	7	0.31	0.27	63	0.26	1.52
Neutral 40	Clear/Clr - Clear/Clr	Neutral Gray	37	0	19	19	11	16	0.31	0.27	72	0.30	1.25
	Green/Clr - Clear/Clr	Green	31	0	13	15	11	9	0.31	0.27	55	0.22	1.40
AG 50	UC/UC - UC/UC	Light Silver	50	0	29	27	19	32	0.28	0.24	82	0.34	1.45
	Clear/Clr - Clear/Clr	Light Silver	46	0	23	26	18	22	0.28	0.24	75	0.31	1.49
	Green/Clr - Clear/Clr	Green	39	0	15	19	17	11	0.28	0.24	57	0.23	1.66
	CrystalGray/Clr - Clr/Clr	Silver Gray	33	0	16	15	17	12	0.28	0.24	59	0.24	1.35
	Gray/Clr - Clear/Clr	Silver Gray	23	0	12	10	17	11	0.28	0.24	52	0.21	1.08
	CrystalBlue/Clr - Clr/Cl	Silver Blue	30	0	16	13	17	14	0.28	0.24	60	0.25	1.21
AG 43	UC/UC - UC/UC	Light Silver	43	0	26	29	15	31	0.28	0.24	77	0.32	1.34
	Clear/Clr - Clear/Clr	Light Silver	40	0	20	28	14	22	0.28	0.24	70	0.29	1.38
	Green/Clr - Clear/Clr	Green	33	0	13	21	14	11	0.28	0.24	53	0.22	1.54
	CrystalGray/Clr - Clr/Clr	Silver Gray	28	0	14	16	14	13	0.28	0.24	55	0.23	1.24
	Gray/Clr - Clear/Clr	Silver Gray	20	0	11	10	13	11	0.28	0.24	50	0.20	0.98
	CrystalBlue/Clr - Clr/Cl	Silver Blue	26	0	14	14	14	14	0.28	0.24	56	0.23	1.11
<b>SunGuard Solar</b>													
Silver 20	Clear/Clr - Clear/Clr	Silver	17	0	10	28	28	20	0.34	0.31	53	0.21	0.78
	Green/Clr - Clear/Clr	Silver Green	14	0	6	21	28	11	0.34	0.31	44	0.17	0.81

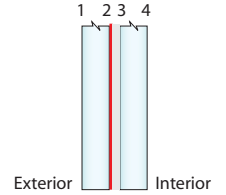

### Laminated Glass Data

Product	Outboard - Inboard Substrate	Appearance	Transmittance			Reflectance			U-Value		Relative Heat Gain	Solar Heat Gain Coefficient	Light to Solar Gain (LSG)
			Visible Light %	Ultra-violet %	Solar Energy %	Visible Light Out %	Visible Light In %	Solar Energy Out %	Winter Night	Summer Day			
<b>SunGuard SuperNeutral</b>			Coating #2 Surface						6 mm/.090 PVB/6 mm				
<b>SN-L 68</b>	Clear/Clear	Clear	67	0	29	11	11	34	0.94	0.85	103	0.40	1.69
	Clear/Green	Green	56	0	21	10	9	33	0.94	0.85	92	0.34	1.63
	Clear/CrystalGray	Light Gray	47	0	21	10	8	33	0.94	0.85	91	0.34	1.39
	Clear/Gray	Gray	34	0	16	9	6	33	0.94	0.85	85	0.31	1.07
	Clear/CrystalBlue	Blue	43	0	20	10	7	33	0.94	0.85	91	0.34	1.27
<b>SunGuard Solar</b>													
<b>Silver 20</b>	Clear/Clear	Silver	19	0	14	30	24	27	0.94	0.85	83	0.31	0.62
	Green/Clear	Silver Green	16	0	8	22	24	12	0.94	0.85	82	0.31	0.52

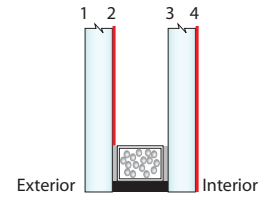

### Insulating Glass Data w/ IS 20

Product	Outboard - Inboard Substrate	Appearance	Transmittance			Reflectance			U-Value		Relative Heat Gain	Solar Heat Gain Coefficient	Light to Solar Gain (LSG)
			Visible Light %	Ultra-violet %	Solar Energy %	Visible Light Out %	Visible Light In %	Solar Energy Out %	Air	Argon			
<b>SunGuard SuperNeutral + IS 20</b>			Coating #2 & IS 20 #4 Surface						6 mm/12.7 mm a.s./6 mm				
<b>SNX 62/27 + IS 20</b>	UltraClear - UltraClear	Ultra Clear	62	8	24	12	13	51	0.23	0.20	62	0.26	2.41
	Clear - Clear	Clear	60	6	22	12	13	40	0.23	0.20	62	0.26	2.33
	Green - Clear	Green	50	3	17	9	12	11	0.23	0.20	55	0.23	2.20
	CrystalGray - Clear	Light Gray	43	3	16	8	12	19	0.23	0.20	51	0.21	2.04
	Gray - Clear	Gray	30	3	12	6	12	19	0.23	0.20	42	0.17	1.78
<b>SNX 51/23 + IS 20</b>	CrystalBlue - Clear	Blue	39	4	15	8	12	25	0.23	0.20	48	0.20	1.97
	UltraClear - UltraClear	Light Blue	51	13	20	14	14	46	0.23	0.20	54	0.22	2.31
	Clear - Clear	Light Blue	50	10	18	14	14	36	0.23	0.20	54	0.22	2.23
	Green - Clear	Blue-Green	42	5	14	11	14	11	0.23	0.20	49	0.20	2.06
	CrystalGray - Clear	Light Gray	35	6	13	9	14	18	0.23	0.20	45	0.18	1.92
<b>SN 68 + IS 20</b>	Gray - Clear	Gray	25	5	10	7	13	17	0.23	0.20	37	0.15	1.65
	CrystalBlue - Clear	Blue	32	6	12	9	13	23	0.23	0.20	43	0.17	1.84
	UltraClear - UltraClear	Ultra Clear	69	37	36	12	13	43	0.24	0.20	91	0.38	1.80
	Clear - Clear	Clear	66	29	32	12	13	33	0.24	0.20	87	0.36	1.82
	Green - Clear	Green	55	13	22	9	12	9	0.24	0.20	68	0.28	1.96
<b>SN 54 + IS 20</b>	CrystalGray - Clear	Light Gray	47	16	23	8	12	17	0.24	0.20	68	0.28	1.67
	Gray - Clear	Gray	33	13	18	6	11	16	0.24	0.20	57	0.24	1.41
	CrystalBlue - Clear	Blue	43	18	22	8	12	21	0.24	0.20	67	0.28	1.54
	UltraClear - UltraClear	Ultra Clear	54	20	25	14	19	44	0.24	0.20	67	0.28	1.97
	Clear - Clear	Clear	52	15	23	14	19	35	0.24	0.20	65	0.27	1.94
<b>SNR 43 + IS 20</b>	Green - Clear	Green	44	7	17	11	18	10	0.24	0.20	55	0.23	1.95
	CrystalGray - Clear	Light Gray	37	8	16	9	18	17	0.24	0.20	53	0.22	1.72
	Gray - Clear	Gray	26	7	12	7	18	16	0.24	0.20	44	0.18	1.45
	CrystalBlue - Clear	Blue	34	9	16	8	18	22	0.24	0.20	51	0.21	1.62
	UltraClear - UltraClear	Light Silver	43	22	20	29	15	54	0.23	0.20	54	0.22	1.97
<b>SN 68 + IS 20</b>	Clear - Clear	Light Silver	42	17	18	28	15	43	0.23	0.20	53	0.22	1.92
	Green - Clear	Green	35	7	13	21	14	14	0.23	0.20	46	0.19	1.85
	CrystalGray - Clear	Silver Gray	30	9	13	16	14	21	0.23	0.20	44	0.18	1.65
	Gray - Clear	Silver Gray	21	7	10	11	14	19	0.23	0.20	38	0.15	1.37
	CrystalBlue - Clear	Silver Blue	27	10	12	14	14	26	0.23	0.20	43	0.17	1.55

**NOTES RELATED TO SUNGUARD IS 20 PERFORMANCE TABLE ABOVE:**

- SunGuard IS 20 coating is on the #4 surface.
- IS 20 is available with SunGuard High Performance and Solar products - contact your SunGuard representative for more information.

## Triple-Glazed Insulating Glass Data

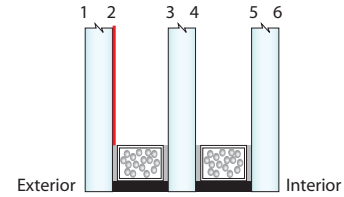

Product	Outboard - Inboard Substrate	Appearance	Transmittance			Reflectance			U-Value Winter Nighttime		Relative Heat Gain	Solar Heat Gain Coefficient	Light to Solar Gain (LSG)
			Visible Light %	Ultra-violet %	Solar Energy %	Visible Light Out %	Visible Light In %	Solar Energy Out %	Air	Argon			
<b>SunGuard SuperNeutral</b>													
			Coating #2 Surface						6 mm/12.7 mm a.s./6 mm/12.7 mm a.s./6 mm				
SNX 62/27	UC - UC - UC	Ultra Clear	59	7	23	15	19	52	0.21	0.18	59	<b>0.24</b>	2.40
	Clr - Clr - Clr	Clear	56	5	21	14	18	40	0.21	0.18	59	<b>0.24</b>	2.29
SNX 51/23	UC - UC - UC	Light Blue	49	12	19	17	20	46	0.21	0.18	51	<b>0.21</b>	2.30
	Clr - Clr - Clr	Light Blue	46	9	17	16	19	36	0.21	0.18	51	<b>0.21</b>	2.19
SN 68	UC - UC - UC	Ultra Clear	65	36	34	15	19	44	0.22	0.18	86	<b>0.36</b>	1.79
	Clr - Clr - Clr	Clear	61	25	29	15	18	35	0.22	0.18	82	<b>0.34</b>	1.79
SN 54	UC - UC - UC	Ultra Clear	52	20	24	16	24	45	0.22	0.18	63	<b>0.26</b>	1.96
	Clr - Clr - Clr	Clear	49	13	21	16	23	35	0.22	0.18	62	<b>0.26</b>	1.91
SNR 43	UC - UC - UC	Light Silver	41	22	19	30	21	55	0.21	0.18	51	<b>0.21</b>	1.95
	Clr - Clr - Clr	Light Silver	39	14	17	29	20	44	0.21	0.18	50	<b>0.21</b>	1.89
<b>Coating #2 &amp; SN 68 #5 Surface</b>													
SNX 62/27*	UC - UC - UC	Ultra Clear	50	4	18	13	14	52	0.16	0.12	57	<b>0.24</b>	2.09
	Clr - Clr - Clr	Clear	47	3	17	13	13	40	0.16	0.12	56	<b>0.23</b>	2.01
SNX 51/23	UC - UC - UC	Light Blue	41	7	15	16	14	46	0.16	0.12	49	<b>0.20</b>	2.01
	Clr - Clr - Clr	Light Blue	39	5	14	15	14	36	0.16	0.12	48	<b>0.20</b>	1.93
SN 68*	UC - UC - UC	Ultra Clear	55	21	25	14	14	45	0.16	0.12	79	<b>0.33</b>	1.65
	Clr - Clr - Clr	Clear	52	15	22	13	13	35	0.16	0.12	75	<b>0.32</b>	1.63
SN 54	UC - UC - UC	Ultra Clear	44	11	18	15	17	45	0.16	0.12	59	<b>0.25</b>	1.77
	Clr - Clr - Clr	Clear	41	8	16	15	17	35	0.16	0.12	57	<b>0.24</b>	1.73
SNR 43	UC - UC - UC	Light Silver	35	12	15	29	15	55	0.16	0.12	48	<b>0.20</b>	1.75
	Clr - Clr - Clr	Light Silver	33	9	13	29	14	44	0.16	0.12	47	<b>0.19</b>	1.70
<b>Coating #2 &amp; Neutral 78/65 #5 Surface</b>													
SNX 62/27	UC - UC - UC	Ultra Clear	57	6	22	14	16	52	0.16	0.13	58	<b>0.24</b>	2.33
	Clr - Clr - Clr	Clear	54	4	20	13	16	40	0.16	0.13	57	<b>0.24</b>	2.25
SNX 51/23	UC - UC - UC	Light Blue	47	10	18	16	17	46	0.16	0.13	50	<b>0.21</b>	2.26
	Clr - Clr - Clr	Light Blue	45	7	16	15	17	36	0.16	0.13	49	<b>0.21</b>	2.17
SN 68	UC - UC - UC	Ultra Clear	63	27	32	14	16	44	0.16	0.13	85	<b>0.36</b>	1.74
	Clr - Clr - Clr	Clear	60	19	28	14	16	34	0.16	0.13	80	<b>0.34</b>	1.75
SN 54	UC - UC - UC	Ultra Clear	50	15	23	15	21	45	0.16	0.13	62	<b>0.26</b>	1.92
	Clr - Clr - Clr	Clear	47	10	20	15	20	35	0.16	0.13	60	<b>0.25</b>	1.89
SNR 43	UC - UC - UC	Light Silver	40	17	18	29	18	54	0.16	0.13	50	<b>0.21</b>	1.92
	Clr - Clr - Clr	Light Silver	38	11	16	29	17	44	0.16	0.13	49	<b>0.20</b>	1.87
<b>Coating #2, Neutral 78/65 #4 Surface, &amp; SunGuard IS 20 #6 Surface</b>													
SNX 62/27	UC - UC - UC	Ultra Clear	56	6	21	14	17	52	0.14	0.12	56	<b>0.23</b>	2.38
	Clr - Clr - Clr	Clear	53	4	19	14	16	40	0.14	0.12	54	<b>0.23</b>	2.30
SNX 51/23	UC - UC - UC	Light Blue	46	9	17	16	18	46	0.14	0.12	48	<b>0.20</b>	2.31
	Clr - Clr - Clr	Light Blue	44	7	16	16	17	36	0.14	0.12	47	<b>0.20</b>	2.23
SN 68	UC - UC - UC	Ultra Clear	61	26	31	14	17	44	0.14	0.12	81	<b>0.34</b>	1.78
	Clr - Clr - Clr	Clear	58	19	27	14	16	34	0.14	0.12	76	<b>0.32</b>	1.80
SN 54	UC - UC - UC	Ultra Clear	49	14	22	15	21	45	0.14	0.12	59	<b>0.25</b>	1.96
	Clr - Clr - Clr	Clear	46	10	19	15	21	35	0.14	0.12	57	<b>0.24</b>	1.94
SNR 43	UC - UC - UC	Light Silver	39	15	17	30	18	55	0.14	0.12	48	<b>0.20</b>	1.96
	Clr - Clr - Clr	Light Silver	37	11	15	29	18	44	0.14	0.12	46	<b>0.19</b>	1.92

\*Review of a full-size mock-up is recommended.

### NOTES RELATED TO ALL SUNGUARD PERFORMANCE TABLES:

- The performance values shown are nominal and subject to variations due to manufacturing tolerances.
- Guardian performance data are calculated for center-of-glass only (no spacer or framing) in accordance with LBNL Window 7 program.
- Glass may require heat strengthening or tempering to resist potential thermal stresses.
- SNR 43 and IS 20 must be heat-treated.
- A slight shift in visible light reflectance or transmission may be noticed after heat-treatment.
- Relative Heat Gain, Solar Heat Gain Coefficient and/or LSG may change slightly when using argon gas fill.
- Guardian recommends edge deletion for all commercial low-E coatings.
- Guardian reserves the right to change product performance characteristics without notice or obligation.

### NOTES RELATED TO LAMINATED GLASS PERFORMANCE TABLES:

- Changes in PVB thickness have little effect on performance data shown.
- When SunGuard coatings are laminated facing the interlayer material, there will be a noticeable color change when compared to standard insulated applications. When SN 68 is laminated facing the interlayer material, the coating's reflected outdoor color, that is the color viewable from the outside of the building, will shift to a red or purple color when viewed from an angle. Guardian recommends a full-size mock-up be approved.

GLASS PERFORMANCE: SPECTRAL GRAPHS

Today's advanced architectural glazing products attempt to balance the demands of aesthetic appearance, energy conservation and building occupant comfort. Theoretically speaking, an "ideal" glazing would transmit 100 percent of the sun's visible energy (light) and reflect, or block, all of the ultraviolet and infrared energy – while providing an aesthetically pleasing appearance from both the exterior and interior of the building. Guardian has scientists dedicated to finding new technologies to achieve the best energy performance possible, coupled with desirable aesthetics to help designers find that balance.

The graphs below show the spectral curves of Guardian SunGuard products on clear and green glass substrates.

**Spectral Curves  
SunGuard Coatings on Clear Glass**

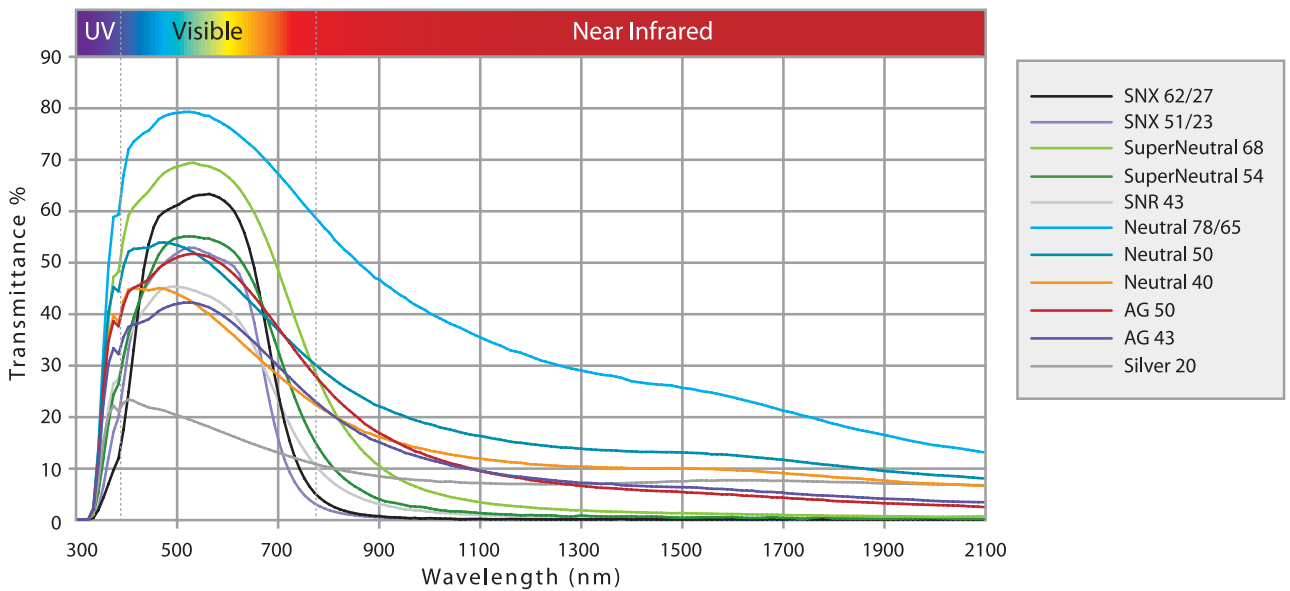

**Spectral Curves  
SunGuard Coatings on Green Glass**

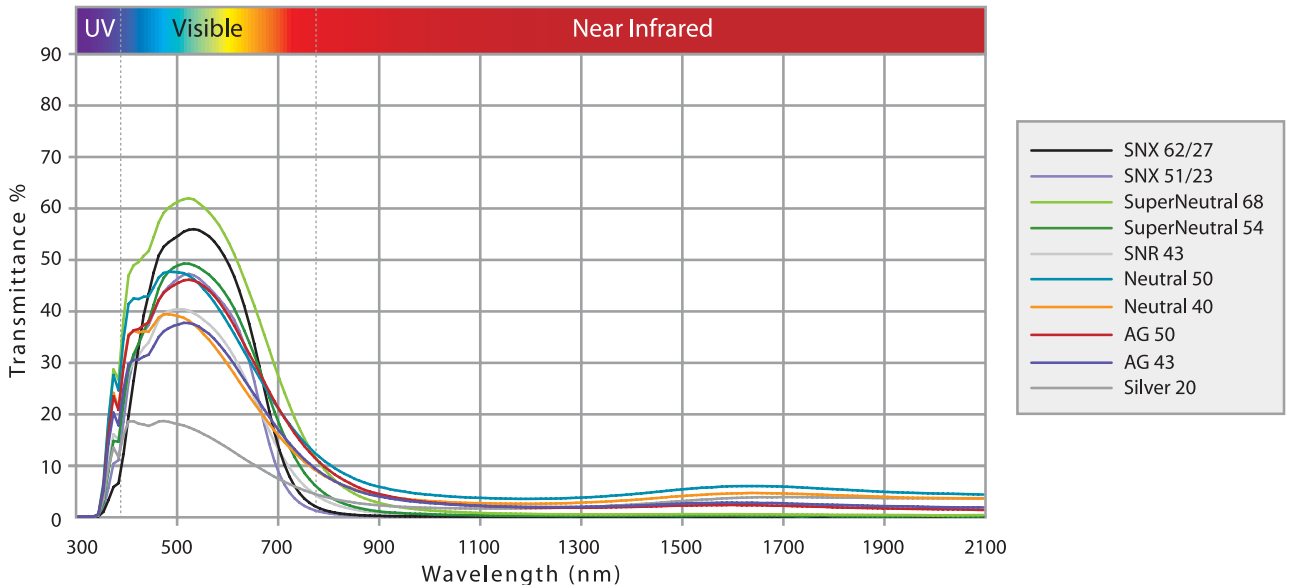



## ACOUSTICAL INFORMATION

The acoustic performance of glazing assemblies is expressed in two terms: Sound Transmission Class (STC) is used to measure the sound transmission loss of interior walls, ceilings and floors; and Outdoor-Indoor Transmission Class (OITC), which measures the sound transmission loss of exterior glazing applications. High sound transmission loss – good sound insulation – is desired in many commercial curtain wall applications. Limiting sound transmission through glazing requires review and testing of the entire glazing system. Laminated glass and insulating glass tend to produce higher OITC ratings because the laminate dampens vibration and the air space limits sound transmission. An important feature of the human perception of continuous sound is that an increase or decrease in sound pressure level by 3 dB or less is barely perceptible; an increase or decrease of 5 dB is clearly perceptible; and an increase or decrease of 10 dB is perceived as a doubling or halving of noise level. For more information, refer to the Glass Association of North America Glazing Manual. The following chart indicates typical laboratory-measured sound transmission losses for various glass configurations.

**Typical Sound Transmission Loss (dB)**

Glass Configuration			Frequency in Hertz (Hz)																	
	STC	OITC	100	125	160	200	250	315	400	500	630	800	1000	1250	1600	2000	2500	3150	4000	5000
1/4"	<b>31</b>	<b>29</b>	23	25	25	24	28	26	29	31	33	34	34	35	34	30	27	32	37	41
1/2"	<b>36</b>	<b>33</b>	26	30	26	30	33	33	34	36	37	35	32	32	36	40	43	46	50	51
1/8" - 0.030" PVB - 1/8"	<b>35</b>	<b>31</b>	25	26	28	27	29	29	30	32	34	35	35	36	36	35	35	38	43	46
1/4" - 0.030" PVB - 1/4"	<b>37</b>	<b>33</b>	28	31	29	31	32	33	32	33	35	36	36	35	36	40	43	46	48	51
1/4" - 0.060" PVB - 1/4"	<b>37</b>	<b>33</b>	27	28	27	30	31	31	33	35	36	37	37	37	36	37	41	44	48	51
1/8" - 3/8"as - 1/8"	<b>31</b>	<b>26</b>	26	23	23	20	23	19	23	27	29	32	35	39	44	47	48	41	36	43
1/4" - 1/2"as - 1/4"	<b>35</b>	<b>28</b>	29	22	26	18	25	25	31	32	34	36	39	40	39	35	36	46	52	58
1/8" - 1/2"as - 1/8" - .030PVB - 1/8"	<b>37</b>	<b>31</b>	27	29	25	24	25	27	29	31	35	38	40	41	42	43	46	50	49	53
1/4" - 1/2"as - 1/8" - .030PVB - 1/8"	<b>39</b>	<b>32</b>	27	27	24	28	26	33	34	35	38	40	42	43	42	40	42	47	51	54
1/4" - 1/2"as - 1/4" - .030PVB - 1/4"	<b>41</b>	<b>35</b>	30	26	30	30	29	36	37	37	39	39	41	42	43	44	46	51	53	55

NOTE: Using acoustical PVB designed specifically for sound attenuation will typically improve STC and OITC rating by 1 dB.

## HOW TO VIEW/EVALUATE GLASS HAND SAMPLES

Coated glass is normally selected based on reflected color, as this is typically seen in outdoor/natural lighting conditions. To see the reflected color of glass, it is best to view samples with a black background. Position the sample so that someone can look at an image that is reflected from the glass surface. This is the true reflected color of the sample.

*Example:* Place a piece of black paper, or other low-gloss black material, on a desktop or other flat surface. Position the glass sample on the paper with the exterior side up, so that you can see the image of the overhead lights being reflected from the glass surface. To view the transmitted color, it is best to view samples using a white background. Evaluating glass samples with a white background will not give a true indication of the exterior appearance of the sample. This instead projects the transmitted color and is not what you will see once the glass is installed in the building.

continued



Guardian recommends that samples be viewed in outdoor/natural lighting conditions, preferably in a slightly overcast condition, for the most accurate rendering of transmitted and reflected color.

Also, architects are encouraged to consider angle of observation, interior lighting conditions and potential effects of glare when choosing glazing products.

When evaluating samples outdoors, we recommend viewing them during various time of the day and under varying lighting conditions, e.g., cloudy versus sunny conditions. This will provide a truer indication of what the glass will look like, as well as give you the opportunity to see how varying light conditions impact your design intent.

We recommend viewing glass samples outdoors whenever possible. After removing the glass from the sample box, place it in a vertical or slightly angled position. Viewing the glass with a black background in the distance is preferred to replicate lighting once installed in the structure. Then look through the glass to provide the best indication of the appearance of installed glass.



# Fabrication and Glazing

What are the guidelines for optical distortion? What can contribute to the risk of glass thermal breakage? How should glass be cleaned? This section provides more detailed information on many important areas related to SunGuard Advanced Architectural Glass.

## OPTICAL DISTORTION

Many conditions may contribute to optical distortion, including glazing errors and fabrication procedures. Minimizing optical distortion resulting from the heat-treatment process will greatly enhance the appearance of the final product. Roll wave and bow and warp are sources of optical distortion that should be carefully specified when design considerations are being evaluated.

Roll wave occurs as glass passes over the rollers in a continuous-operation, heat-treating furnace. As the glass heats up, it may sag between rollers and become “frozen” in place during the cooling (quench) process. This may produce roller wave distortion in the finished product. Guardian recommends that:

- Glass should be processed so roll wave will be horizontal to the base dimension of the finished unit, whenever possible.
- A roll distortion gauge should be used to measure roll distortion.
- A target of 0.07mm (0.003") with a maximum of 0.13mm (0.005") roll wave for any commercial application.

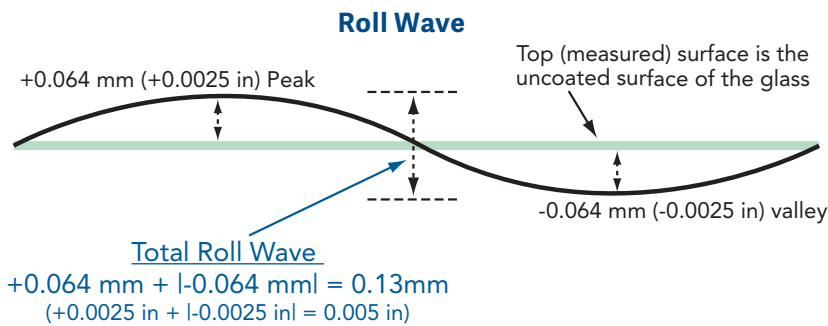

Bow and warp occurs as a result of the heat-treating process and can be reduced through the proper use of heat-up maximum temperature/cycle time and cool-down cycle time/temperature.

- ASTM C 1048 addresses bow and warp and states that localized bow and warp may be determined with the use of a straight edge spanning the concave surface. The glass must be measured with a feeler gauge or dial indicator.
- Guardian requires independent Select Fabricators to use half of the ASTM guideline as a target in production.

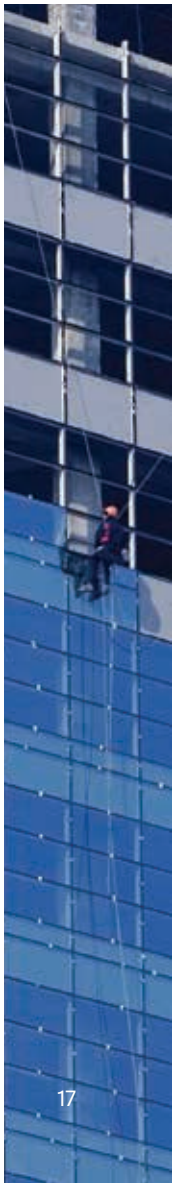

## THERMAL BREAKAGE

Thermal breakage can be influenced by a number of factors. A critical factor to consider in the early stages of glass selection is whether the glass will be shaded. When glass is partially shaded by building overhangs or extensions, it becomes cooler at the edges and stress in the glass may occur, which can result in thermal breakage.

In areas where thermal breakage may be of concern, a thermal breakage analysis must be completed to determine if heat-treating (heat-strengthening or tempering) may be needed. Heat-treating may also be necessary due to high wind loads or safety glass code requirements. The degree to which the central area of the glass becomes hot is largely dependent on the solar absorption of the glass, which varies between different types of glass.

Some additional factors that may influence thermal breakage are listed below:

- Glass framing that is in direct contact with concrete or other materials that may contribute to the cooling of the glass edge.
- Highly-reflective or highly-insulating framing.
- Excessive coverage of the glass edge by the frame.
- Tinted glass or heat-absorbing films attached to the glass after installation.
- Triple-glazing with elevated thermal loads on the coated lite(s) and middle lite.
- Spandrel glazing, especially the inboard lite.
- The use of internal shading devices such as curtains, drapes or venetian blinds – if shading devices are used, they must be placed away from the glass to allow for a free flow of air at the glass surface.
- The airflow from room cooling or heating vents must be directed away from the glass.
- Buildings not heated during the construction phase may experience an increase in thermal breakage.
- Generally, the greater the glass edge area, the greater the risk of thermal breakage.

The potential risk of thermal breakage can be estimated by a computer-aided thermal stress analysis. Contact your Regional Technical Advisor for assistance with thermal stress analysis.

## CONSTRUCTION-PHASE RISKS OF THERMAL BREAKAGE

There is a higher risk of thermal stress breakage during the construction phase of a project, and such breakage may diminish once the building is closed in and heated.

Thermal stress breakage is caused primarily by a temperature gradient developing between the edge and center portions of the glass pane. The most critical exposure in which thermal breakage can occur is under conditions when the glass edges are cold and the central region is heated. This condition is common in buildings with overhangs and vertical extensions.

Thermal stresses present during construction occur particularly when the building interior is not heated, and the panes of glass are exposed to direct sunlight. In such cases, breakage can occur as the sun heats the central portion of the glass, while the edges are cooled by the frame.





This type of breakage is possible even with the absence of overhangs or vertical extensions. The risk is greatest for heat-absorbing glass, such as tints and reflective glass. In insulating glass, the risk of thermal breakage is further increased when heat-absorbing tinted glass is used.

The best control of thermal breakage is heating the interior of the building and specifying heat-treated glass, either heat-strengthened or tempered. This graph shows the dramatic extent to which heating the building decreases risk of breakage from thermal stress. Guardian Glass will provide an analysis of the risk of thermal breakage during construction if the anticipated building temperatures and appropriate window details are provided. However, a thermal stress analysis is not a guarantee against breakage. The analysis is a service to our customers for the purpose of product selection. The selection of product type and prevention of thermal breakage are the responsibility of the design professional.

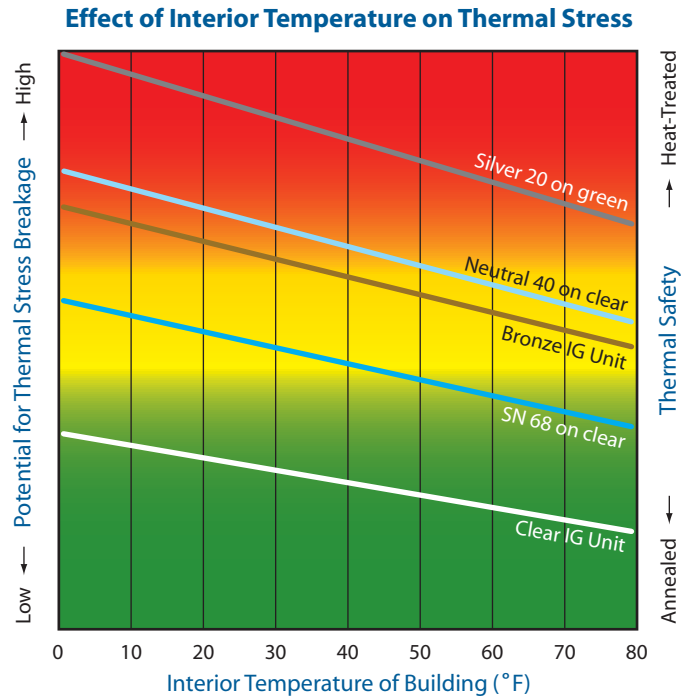

**STATISTICAL PROBABILITY OF GLASS BREAKAGE**

Glass is a brittle material. It acts elastically until it fractures at ultimate load. That ultimate load varies, depending upon the type and duration of the loads applied and the distribution, orientation and severity of the inhomogeneities and micro-flaws existing in the surface of the glass. Because of its nature, glass cannot be engineered in the same way as other building envelope materials with a predictable specific strength. In those cases, factors can be (and are) assigned to minimize the likelihood that breakage will occur at the selected design load. Because the ultimate strength of glass varies, its strength is described statistically. Architects and engineers, when specifying a design factor for glass in buildings, must choose the anticipated wind load, its duration and the probability of glass breakage (defined as x per 1000 lites of glass at the initial occurrence of the design load). Glass manufacturers can provide the appropriate data for determining the performance of their products. However, the responsible design professional must review these performance criteria and determine if they are suitable for the intended application.



## HEAT-SOAKING

All float glass contains some level of imperfection. One type of imperfection is nickel sulfide (NiS) inclusions. Most NiS inclusions are stable and cause no problems. There is, however, the potential for NiS inclusions that may cause spontaneous breakage in tempered glass without any load or thermal stress being applied.

Heat-soaking is a process that may expose NiS inclusions in tempered glass. The process involves placing the tempered glass inside a chamber and raising the temperature to approximately 290°C to accelerate nickel sulfide expansion. This causes glass containing nickel sulfide inclusions to break in the heat soak chamber, thus reducing the risk of potential field breakage. The heat-soaking process is not 100 percent effective, adds cost and carries the risk of reducing the compressive stress in tempered glass.

Heat-strengthened glass has a much lower potential incidence of spontaneous breakage than tempered glass. For applications where additional glass strength is required due to thermal stress, and safety glass is not mandated, Guardian recommends heat-strengthened or laminated glass to reduce the potential for spontaneous breakage.

## WIND LOAD

Guardian follows the current ASTM E 1300 Standard Practice for Determining the Minimum Thickness and Type of Glass Required to Resist a Specified Load. This information represents in-service glass and supersedes the traditional straight-line graph as well as other wind load charts. The ASTM wind load standard is applicable to projects built in the United States. Wind load standards for other countries may differ, and must be addressed in the early stages of design. Contact your Regional Technical Advisor for assistance with wind load analysis.

**Glass Center Deflection:** An important consideration in the choice of glass is center deflection. Excessive center deflection can result in edge pullout, distortion of reflected images and possible glass contact with interior building components, e.g., room dividers and interior blinds.

**Insulating Glass:** The effects of wind on insulating glass units are, in many cases, complex and require a computer-assisted wind load analysis to adequately consider some of the variables. Design professionals must take into account the following variables:

- Load sharing other than 50-50.
- Air space contraction and expansion due to changes in temperature, barometric pressure and altitude variation in weathering of the glass surfaces, e.g., surface #1 vs. surface #2.
- Edge condition – free or fixed.
- Asymmetrical loading, i.e., lites of varying thickness.
- Variation in sightline or airspace width.
- Thermal stress.

When all or some of these variables are taken into account, the maximum wind load may differ considerably from the data taken from a wind load chart.



## BENDING GUARDIAN SPUTTER-COATED GLASS

SunGuard heat-treatable coatings are thermally stable and have been utilized in bent glass applications. SunGuard products used in bent glass applications maintain their aesthetic, optical and performance properties. Bending constraints are based on coating thickness, radius and concave vs. convex applications. The bending of SunGuard products must only be performed by independent Guardian Select Fabricators. Guardian recommends a full-scale mock-up be fabricated and viewed prior to final specification approval. Please contact your Regional Technical Advisor for complete information regarding bent glass applications.

## STRAIN PATTERN

Strain pattern refers to a specific geometric pattern of iridescence or darkish shadows that may appear under certain lighting conditions, particularly in the presence of polarized light (also called “quench marks”). The phenomena are caused by the localized stresses imparted by the rapid air cooling of the heat-treating operation. Strain pattern is characteristic of heat-treated glass and is not considered a defect.

## MOIRÉ PATTERNS

Moiré is an optical phenomenon that may appear as a wavy, rippled or circular pattern under certain lighting conditions. Moiré patterns may be created when one semitransparent object with a repetitive pattern is placed over another and the two are not aligned. The moiré patterns are not defects in the glass or silk-screen pattern – they are a pattern in the image formed by the human eye. This may occur when silk-screen patterns of lines or dots are closely spaced, and a secondary pattern is created by the shadow of the ceramic frit on another surface of an insulating glass unit, for instance, when a spandrel panel is installed behind silk-screened glass. Another potential moiré pattern may be the result of light transmitted through the glass portion not covered with ceramic frit.

## GLASS EDGE TYPES

The condition of the edge of finished glass products can impact the long-term structural performance of the glass system. The table of edge types is provided to help design professionals understand fabrication processes and typical applications.

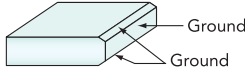
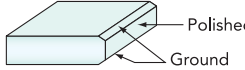
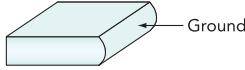
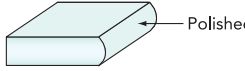
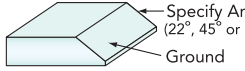
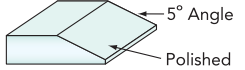
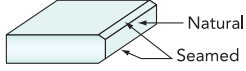
Edge Diagram	Description	Typical Applications
	Flat Ground	Silicone structural glazing with exposed edges
	Flat Polish	Silicone structural glazing where edge condition is critical for aesthetic purposes
	Ground Pencil Edge	Mirrors, Decorative furniture glass
	Polished Pencil Edge	Mirrors, Decorative furniture glass
	Ground Miter	Silicone structural glazing
	Bevel	Mirrors, Decorative furniture glass
	Seamed Edges	Normal edge treatment for heat-treated glass

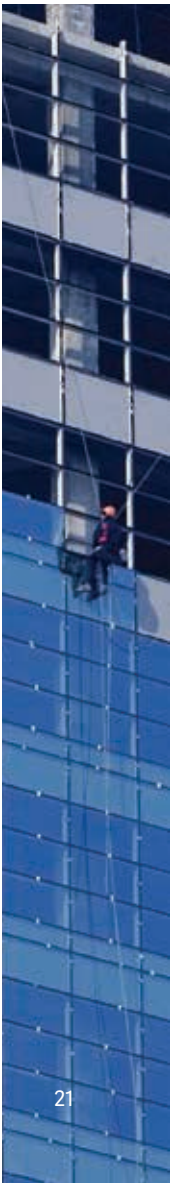

## GLASS HANDLING, STORAGE, MAINTENANCE AND CLEANING

Glass is a hard substance, but it can be scratched. It is resistant to many, but not all, chemicals. Glass is generally a durable material, and if properly maintained, can last almost forever.

One of the most harmful materials to glass is glass itself. When glass is stored prior to fabrication, it should be separated by an airspace, separator or paper. When removing glass from storage, avoid sliding one pane over another, as they can be scratched or abraded. Glass edges should not contact the frame or other hard surfaces during installation. Use rolling blocks, as necessary, when moving glass.

Glass should be washed frequently to remove surface dirt and also to protect the glass from staining. Glass staining occurs when the sodium within the glass reacts with moisture in the air. Sodium, when combined with small amounts of water, can create sodium hydroxide, which is corrosive to glass. If this sodium hydroxide is left on the glass surface for a prolonged period of time, the glass will be permanently damaged and may have to be replaced. The sodium hydroxide is easily removed with water and normal glass-cleaning solutions, e.g., alcohol and water, or ammonia and water. Installed glass is less prone to sodium hydroxide damage due to the natural cleansing of the glass surface by rain.

### ***Recommended Cleaning Or Washing Solutions***

#### ***A. General Glass Cleaning***

- Use water applied by a saturated cloth.
- Use pre-mixed glass-cleaning solutions. Follow all printed instructions. Immediately remove all pre-mixed cleaning solutions with a soft, dry cloth.
- Use a 50-50 mixture of alcohol and water, or ammonia and water, followed by a warm rinse. Glass must be dried with a soft cloth or a chamois and cellulose sponge.

#### ***B. Precautions***

- Avoid abrasive or highly alkaline cleaners. Do not use petroleum products, i.e., gasoline, kerosene or lighter fluid.
- Hydrofluoric and phosphoric acid are corrosive to the glass surface and should not be used.
- Protect the glass surface from over-spray or runoff from acids and cleaning agents used to clean metal framing, brick or masonry.
- Keep all cleaning solutions and other materials from contacting the edges of laminated glass or insulated glass.
- Do not use abrasive brushes, razor blades or other objects that may scratch the glass.
- Immediately remove any construction materials, i.e., concrete, fireproofing, paints, labels and tapes.
- Clean a small area at a time, and inspect the glass surface frequently to ensure that no glass damage has occurred.
- For most effective results, clean glass at a time when its surface is shaded. Avoid direct sunlight or hot glass.





## FLOAT & COATED GLASS: MINIMUM & MAXIMUM SIZES

Minimum and maximum glass sizes are determined by float glass and coated glass manufacturing capabilities. The maximum coated glass size currently produced by Guardian is 102" x 168"; not all products are available at this maximum size, please contact your Regional Technical Advisor for complete manufacturing capabilities. To determine the minimum and maximum sizes available for finished glass products, the glass fabricator must be consulted. Physical/mechanical capabilities and constraints of the fabricator will affect the final finished glass size availability.

## OVERSIZE GLASS: INSULATING AND HEAT-TREATMENT CONSIDERATIONS

It is important for designers to understand that the maximum glass sizes available from float glass and coated glass manufacturers like Guardian do not suggest that insulating glass unit and heat-treatment equipment capabilities can process these sizes. To the contrary, there are many considerations that need to be taken into account when designing glazing for today's architecture.

Maximum glass sizes are dictated by the size of glass available from the primary manufacturer, the fabrication equipment limitations, the capabilities of the contract glazier to install the unit, availability of specialized shipping and handling equipment to deliver the unit, and the specific glass makeup, such as coated glass, silk-screened glass, heat-treated glass, laminated glass, insulating glass or some combination of these items. Generally speaking, glass that is 60" or less in width can be heat-treated on a high-speed furnace, which will make the glass more economical and more readily available. Glass from 60" to 84" in width is available from a number of fabricators, and some have capability up to 96", but the cost may be higher. Once the total size of the insulating unit exceeds 50 square feet, the number of potential glass fabricators will diminish, and the cost will go up significantly. Many fabricators have a standard practice of heat-treating both lites of an insulating glass unit when the unit size exceeds 35 square feet, and unit sizes over 50 square feet will almost always require this practice. Fabricators providing heat-treated glass may also recommend oversize glass to be tempered rather than heat-strengthened to better control overall flatness. Guardian recommends the specific glass makeup be reviewed with a glass fabricator so that the availability of glass to meet project lead times and budget can be confirmed.

## GLAZING GUIDELINES

All glass products are to be glazed in a manner that ensures the glass is free-floating, non-load-bearing and glazed with a material that remains resilient. An adequate weep system, or materials which totally repel the passage of water, is necessary to avoid premature failure of fabricated glass, opacified spandrel and laminated glass. Adequate clearance for bow and warp of heat-strengthened and tempered glass must be provided as specified in ASTM Standard C 1048. For complete industry-accepted information about glazing guidelines, please review the Glass Association of North America's Glazing Manual.

*continued*

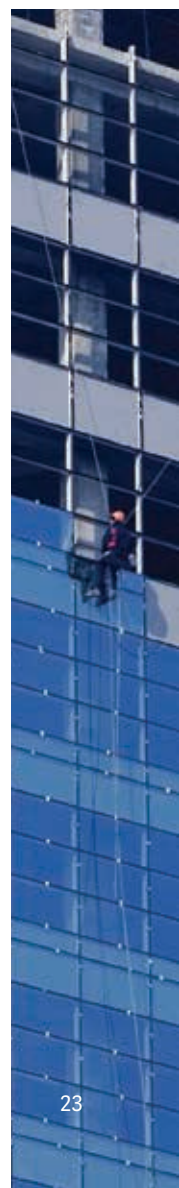

**Conventional Glazing:**

- Framing must be structurally sound, with sufficient strength to support the glass weight without any sagging, twisting or deformation that may impose a load on the glass.
- No framing member should deflect more than 1/175 of its span, with a maximum deflection of 3/4" when under load. Framing exceeding 15'-6" is limited to deflection of  $L/240 + 1/4"$ .
- Appropriate setting blocks, face gaskets, wedges and edge spacers must meet current requirements of ASTM Standards C 864 and D 395 for hardness, deformation, compression set and polymer content.
- Framing members must be free of any glazing obstructions that would result in glass damage.
- Minimum framing extension is necessary to reduce the likelihood of thermal breakage. In situations where thermal breakage may be a concern, request a thermal stress analysis.
- Blocking should be implemented to reliably prevent glass-to-metal contact under the most severe in-plane movements between the glass and its frame.

**Silicone Structural Glazing:**

- Glass is not typically used as a structural member. Support framing must be of sufficient strength and dexterity to absorb all loads resulting from wind, thermal expansion or building movement.
- Backup mullions are recommended for glass thickness 1/4" or less and in all instances where insulating glass is specified.
- Higher light-transmitting coating may show edge read-through. Insulating glass used in structural glazing must be silicone units.
- Opacified spandrel must have trim in the back of the opacifier to ensure glass-to-silicone adhesion.
- The compatibility and adhesive characteristics of the structural silicone are to be confirmed in the early stages of design.

**Dry Glazing**

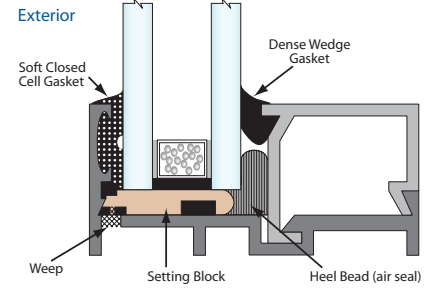

**Wet Glazing**

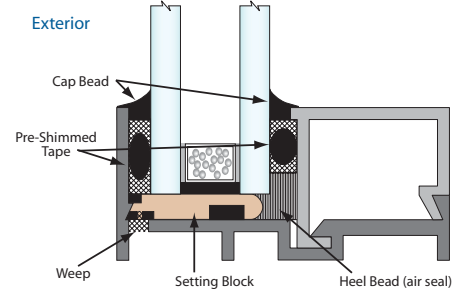

**Pressure Glazing**

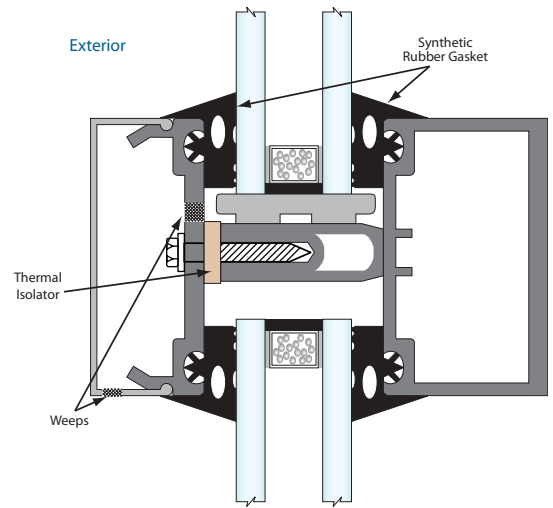

**Silicone Structural Glazing**

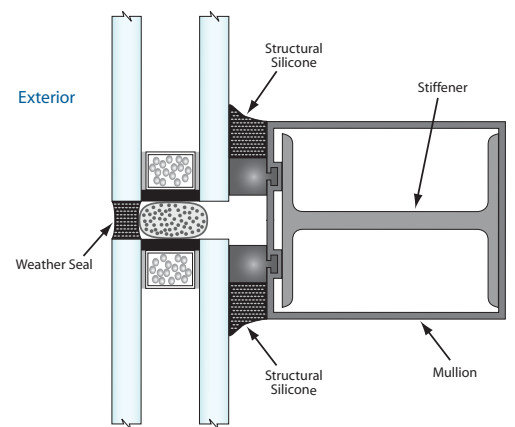

## QUALITY/INSPECTION GUIDELINES

The following quality standards are offered as suggested guidelines for the evaluation of coated glass products, based on ASTM 1376.

### General:

- Normal viewing distance is 10 feet for vision glass and 15 feet for spandrel glass. The viewing angle should be 90°. Vision glass is viewed against a bright, uniform background.
- The area of most importance is the central viewing area, which is defined by 80% of the length and 80% of the width dimensions centered on a lite of glass. The remaining area is considered the outer area.

### Pinholes and Clusters (viewed in transmission):

- Pinholes up to 1.5mm (1/16") are acceptable.
- A cluster is defined as two or more pinholes up to 1.5 mm (1/16") each that are readily apparent and located in an area of 75 mm (3") diameter.
- Clusters of pinholes within the central viewing area are not acceptable.
- Clusters greater than 0.82 mm (1/32") and visible from 3 meters (10 feet) are acceptable only outside the central viewing area.

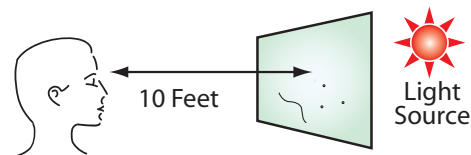

### Scratches (viewed in transmission):

- Scratches longer than 50 mm (2") within the central viewing area are not acceptable.

### Color uniformity (viewed in reflection):

- Coated glass may exhibit slightly different hue or color that may not be apparent in hand samples.
- Color and reflectance may vary slightly overall and be considered acceptable.
- Due to the reflectivity of some glass coatings, distortion of reflected objects may be more apparent. This characteristic is more pronounced with heat-treated, laminated and insulated glass.

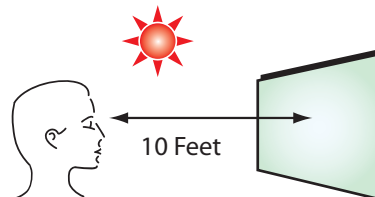

### Spandrel Glass (viewed in reflection):

- Coated glass may exhibit slightly different hue or color that may not be apparent in hand samples.
- Color and reflectance may vary slightly overall and be considered acceptable.
- Pinholes up to 3.0 mm (1/8") are acceptable.
- Scratches up to 75 mm (3") are acceptable.

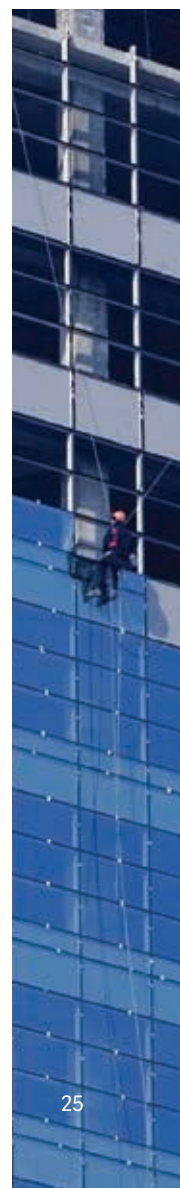
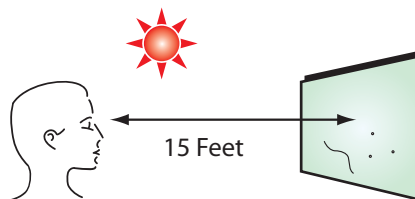

## Other Resources

---

### ARCHITECTURAL TOOLS

Guardian offers a full line of architectural glass products. We also offer several tools online designed to help architects find solutions and specify Guardian products, including:

- Our PRODUCT MASTERSPEC™ is based on Section 088100 from the AIA MASTERSPEC® library, and it helps simplify the preparation of specification documents.
- CSI 3-part specifications for SunGuard products.
- SunGuard 3-part specifications in association with BSD SpecLink.
- USGBC LEED® brochure for architects looking for LEED certification through the use of high-performance glass.
- Glass Analytics online suite of engineering and analytic tools for glass. These online tools offer a comprehensive suite of engineering and analytical reports that demonstrate the advantages of high performance glass in building facades and include:
  - SunGuard's Performance Calculator to model the thermal and optical properties for a glass make-up ranging from monolithic uncoated glass to highly complex combinations of float glass substrates, coatings and interlayers.
  - The Guardian Glass Visualizer dynamically generates photo-realistic images of both exterior and interior glazing views. It allows the user to evaluate the aesthetic properties of virtually any glass make-up. Just choose the glass you want to visualize, select the building and perspective that suits you, and watch how various sky conditions affect the appearance of the glass.
  - The Building Energy Calculator uses the make-ups created in the Performance Calculator to compare energy cost, consumption and financial payback information based on hourly simulations of glazing options, building parameters and project location. This tool offers architects and other project specifiers a comprehensive tool to evaluate commercial glazing options and their impact on energy use and design. Users can perform energy analyses of various combinations of glazing products, including products from other manufacturers. This free, web-based service helps users set up a project with prototypical building type and building details. The calculation engine applies utility rates and specific weather data for 52 cities in the U.S., Canada and Mexico to generate energy cost and consumption data.
  - The Guardian BIM Generator provides thermal and optical performances of the project specific custom IG makeups. It is highly detailed content with visibility settings to control the level of detailing depending on the scale of the view. The content is created for Revit to take advantage of the material analytics for project specific energy simulations. Parameters give the ability to control the dimensions of the spacer systems, the glass bite of the unit and to calculate the weight of individual insulating glass units. Any fabrication needs for heat treatment or lamination can be specified which allows for a more detailed glazing schedule and material takeoffs.
- Searchable online commercial project database, including photos and information.
- Smartphone apps that allow interaction with hundreds of projects worldwide and demonstrate energy conservation concepts.



## NATIONAL, REGIONAL AND LOCAL BUILDING CODES/STANDARDS

The evolution of building construction has led to the development of codes and standards that mandate structurally sound, energy-efficient and environmentally conscious buildings. Many of these codes and standards apply directly to glazing components and should be thoroughly investigated prior to design finalization. A few of the applicable standards include:

- ANSI Z 97.1 Glazing Materials Used in Buildings, Safety Performance Specifications and Methods of Test
- ASTM C 1036 Standard Specification for Flat Glass
- ASTM C 1048 Standard Specification for Heat-Strengthened and Fully Tempered Flat Glass
- ASTM C 1464 Standard Specification for Bent Glass
- ASTM C 1172 Standard Specification for Laminated Architectural Flat Glass
- ASTM C 1376 Standard Specification for Pyrolytic and Vacuum Deposition Coatings on Flat Glass
- ASTM E 1300 Standard Practice for Determining Load Resistance of Glass in Buildings
- ASTM E 1886 Standard Test Method for Performance of Exterior Windows, Curtain Walls, Doors, and Impact Protective Systems Impacted by Missile(s) and Exposed to Cyclic Pressure Differentials
- ASTM E 1996 Standard Specification for Performance of Exterior Windows, Curtain Walls, Doors, and Impact Protective Systems Impacted by Windborne Debris in Hurricanes
- ASTM E 2188 Standard Test Method for Insulating Glass Unit Performance
- ASTM E 2190 Standard Specification for Insulating Glass Unit Performance and Evaluation
- ASTM F 1642 Standard Test Method for Glazing and Glazing Systems Subject to Airblast Loadings
- CPSC 16CFR-1201 Safety Standard for Architectural Glazing Materials
- International Building Code (IBC) - Chapter 24

## WARRANTY

Guardian provides a coated glass products warranty to our direct customer, typically the glass fabricator, for a period of 10 years. This covers the coated glass only – the insulating glass units will typically be covered by a warranty provided by the fabricator. Similarly, Guardian laminated glass products are covered by a 5-year warranty. Contact your Guardian Sales Representative for a copy of specific product warranty documents.

A wide range of documents, including 3-part specifications in CSI format, product flyers, brochures, AIA/CES presentation information and other technical documents are published online. Please visit [www.SunGuardGlass.com](http://www.SunGuardGlass.com) or call us at 1-866-GuardSG (482-7374).

## Glossary

---

### COLOR RENDERING INDEX (CRI)

The ability of transmitted daylight through the glazing to portray a variety of colors compared to those seen under daylight without the glazing. In illumination, general color rendering indices above 90 are very good and between 80 and 90 are good. For instance, a low CRI causes colors to appear washed out, while a high CRI causes colors to appear vibrant and natural. In commercial glass, CRI indicates the effect the specific glass configuration has on the appearance of objects viewed through the glass.

### HEAT GAIN

Heat gain is heat added to a building interior by radiation, convection or conduction. Building heat gain can be caused by radiation from the sun or the heat in hot summer air convected/ conducted to the building interior.

### HEAT TRANSFER METHODS

Heat transfer occurs through convection, conduction or radiation (also referred to as "emission"). Convection results from the movement of air due to temperature differences. For instance, warm air moves in an upward direction and, conversely, cool air moves in a downward direction. Conduction results when energy moves from one object to another by direct contact. Radiation, or emission, occurs when heat (energy) can move through space or an object and then is absorbed by a second object.

### HYBRID: LOW-E/REFLECTIVE COATINGS

A combination of medium outdoor reflectivity and low-E performance qualities. These coatings allow the designer to combine low U-values, reduced solar heat gain and visual aesthetics. Guardian offers SNR 43, AG 43 and AG 50.

### INFRARED (LONG-WAVE) ENERGY

Energy generated by radiated heat sources such as electric coil heaters or natural gas-powered, forced-air furnaces. Also, any object that can absorb heat and radiate it is producing long-wave, infrared energy. *NOTE:* When short-wave energy from the sun is absorbed and radiated by glazing, it is converted to long-wave energy.

### LIGHT-TO-SOLAR GAIN (LSG)

Ratio of the visible light transmittance to the Solar Heat Gain Coefficient.  $LSG = T_{vis} / SHGC$ . A higher LSG ratio means sunlight entering the room is more efficient for daylighting, especially for summer conditions where more light is desired with less solar gain. This ratio is the measurement used to determine whether the glazing is "spectrally selective," which is defined by the U.S. Dept. of Energy as 1.25 or higher.

## LOW-E COATINGS

Relatively neutral in appearance, low-E coatings reduce heat gain or loss by reflecting long-wave infrared energy (heat) and, therefore decrease the U-Value and improve energy efficiency. Current sputter-coated low-E coatings are multilayered, complex designs engineered to provide high visible light transmission, low visible light reflection and reduce heat transfer. SunGuard SNX 62/27, SNX 51/23, SN 68, SN 54, Neutral 78/65, Neutral 50 and Neutral 40 are low-E coatings.

## RELATIVE HEAT GAIN (RHG)

The total heat gain through glass for a specific set of conditions. This value considers indoor/outdoor air temperature differences and the effect of solar radiation. The units are Btu/(hr.ft<sup>2</sup>).

$$RHG = [(89.6^{\circ}F - 75.2^{\circ}F)(\text{Summer U-Value}) + (200 \text{ Btu/hr.ft}^2)(\text{Shading Coefficient})]$$

## R-VALUE

A measure of the resistance of the glazing to heat flow. It is determined by dividing the U-Value into 1, (R-Value = 1/U-Value). A higher R-Value indicates better insulating properties of the glazing. R-Value is not typically used as a measurement for glazing products and is referenced here to help understand U-Value.

## SHADING COEFFICIENT (SC)

An alternative measure of the heat gain through glass from solar radiation. Specifically, the shading coefficient is the ratio between the solar heat gain for a particular type of glass and that of double-strength clear glass. A lower shading coefficient indicates lower solar heat gain. For reference, 1/8" (3 mm) clear glass has a value of 1.0. (SC is an older term being replaced by the SHGC).

## SOLAR CONVERSIONS

- **Direct Solar Transmittance:** Solar Energy Transmittance
- **Shading Coefficient:** Solar Heat Gain Coefficient/0.86
- **Indirect Solar Transmittance:** Solar Heat Gain Coefficient - Direct Solar Transmittance
- **Absorptance:** 1 - Direct Solar Transmittance - Solar Reflectance

*Units of Measure:*

<u>U-Value</u>	<u>Relative Heat Gain</u>
$\frac{\text{Btu}}{\text{hr}\cdot\text{ft}^2\cdot^{\circ}\text{F}} \times 5.6783 = \frac{\text{W}}{\text{m}^2\cdot\text{K}}$	$\frac{\text{Btu}}{\text{hr}\cdot\text{ft}^2} \times 3.1546 = \frac{\text{W}}{\text{m}^2}$
$\frac{\text{Btu}}{\text{hr}\cdot\text{ft}^2\cdot^{\circ}\text{F}} \times 4.887 = \frac{\text{Kcal}}{\text{hr}\cdot\text{m}^2\cdot^{\circ}\text{C}}$	$\frac{\text{Btu}}{\text{hr}\cdot\text{ft}^2} \times 2.715 = \frac{\text{Kcal}}{\text{hr}\cdot\text{m}^2}$

**Note:** These conversions address units of measure. For information on performance properties calculated by methods other than NFRC standards, contact your Regional Technical Advisor.

## SOLAR ENERGY

Radiant energy from the sun having a wavelength range of 300 to 4000 nm, which includes UV (300 to 380 nm), visible light (380 to 780 nm) and near infrared energy (780 to 4000 nm).

- **% Reflectance Out** – percentage of incident solar energy directly reflected from the glass back outdoors.
- **% Absorptance** – percentage of incident solar energy absorbed into the glass.
- **% Transmittance** – percentage of incident solar energy directly transmitted through the glass.

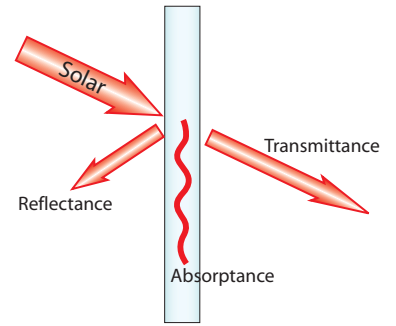

The sum of percent reflectance out + absorptance + transmittance = 100%. An additional consideration is emission, or emissivity. This refers to the reradiation of absorbed energy that can be emitted toward both the exterior and interior of the building. Emissivity is controlled through the use of low-emissivity, or low-E coatings.

## SOLAR HEAT GAIN COEFFICIENT (SHGC)

The percent of solar energy incident on the glass that is transferred indoors, both directly and indirectly through the glass. The direct gain portion equals the solar energy transmittance, while the indirect is the fraction of solar incident on the glass that is absorbed and re-radiated or convected indoors. For example, 1/8" (3 mm) uncoated clear glass has a SHGC of approximately 0.86, of which 0.84 is direct gain (solar transmittance) and 0.02 is indirect gain (convection/re-radiation).

## SOLAR/REFLECTIVE COATINGS

Typically, highly reflective coatings that reduce solar heat gain through reflection and absorption. Though very effective at reducing heat gain, visible light transmittance is generally low and U-Values are not as energy efficient as low-E coatings. Guardian offers SunGuard Silver 20 in this product category.

## SPECTRALLY SELECTIVE GLAZING

High-performance glazing that admits as much daylight as possible, while preventing transmission of as much solar heat as possible. By controlling solar heat gain in summer, preventing loss of interior heat in winter, and allowing occupants to reduce electric lighting use by making maximum use of daylight, spectrally selective glazing significantly reduces building energy consumption. The United States Department of Energy has established a Light-to-Solar Gain Ratio of 1.25 as the minimum measurement to be classified as a "Spectrally Selective Glazing." The calculation of spectrally selective glazing follows the formula described in the Light-to-Solar Gain definition on page 28.



## TRANSMITTANCE PERCENT

Percentage of incident energy that directly passes through the glass.

## UV

Ultraviolet radiant energy from the sun having a wavelength range of 300 to 380 nm with air mass of 1.5. Long-term exposure to UV light may result in fabric and pigment fading, plastic deterioration and changes to the appearance of many types of wood.

## U-VALUE (U-FACTOR)

A measure of the heat gain or loss through glass due to the difference between indoor and outdoor air temperatures. It is also referred to as the overall coefficient of heat transfer. A lower U-Value indicates better insulating properties. The units are Btu/(hr·ft<sup>2</sup>·°F).

## VISIBLE LIGHT

Radiant energy in the wavelength range of 380 nm to 780 nm with Ill. D65 and CIE 2° observer.

- **% Transmittance** ( $T_{vis}$ ) – percentage of incident visible light directly transmitted through the glass.
- **% Reflectance Indoors** – percentage of incident visible light directly reflected from the glass back indoors.
- **% Reflectance Outdoors** – percentage of incident visible light directly reflected from the glass back outdoors.





**BUILD WITH LIGHT<sup>®</sup>**



**SUNGUARD®**  
Advanced Architectural Glass

[www.SunGuardGlass.com](http://www.SunGuardGlass.com) • 1-866-GuardSG (482-7374)



*See what's possible™*

SunGuard, Build With Light, SuperNeutral, CrystalGray,  
CrystalBlue, UltraClear and MidnightGray  
are trademarks of Guardian Glass, LLC.

© 2018 Guardian Glass, LLC v.5.2018

**Please file in 088100 Glass.**